OPERATOR'S MANUAL

FOR THE

MANTIS™ MODEL 10010

50-TON DIESEL-POWERED,

HYDRAULICALLY-OPERATED

CRAWLER CRANE



Manufactured By

SpanDeck
N C O R P O R A T E D

P.O. Box 99
Confederate Drive
Franklin, Tennessee 37065
Phone: (615) 794-4556
FAX: (615) 790-6803

TABLE OF CONTENTS

1.	OVERVIEW	1
	Manual Organization	1
	Operator Alerts	2
	Directional References	2
	Capacity Limits and General Conditions	2
	Lubrication and Maintenance	3
2.	DASH/CONTROL PANELS	5
	Engine Controls	6
	Swing Right/Left Controls	8
	Telescope Out/In Control; Boom Hoist Control	9
	Main Winch/Auxiliary Winch Controls	10
	Travel Controls; Tracks Extend/Retract Switch	11
	Auxiliary Equipment Controls	12
	Other Operator Controls	13
3.	LOAD MOMENT INDICATOR/ANTI-TWO-BLOCK SYSTEM	15
	Load Moment Indicator	15
	Load Chart Selection & Load Moment Indicator Setting	15
	Anti-Two-Block (A2B)	16
4.	ENGINE OPERATION	17
	Alarm Systems	17
	Walk-Around Inspection	17
	Electric Starting	19
	Starting With Jumper Cables	20
	After Starting The Engine	21
	Engine Stopping	21
	After Stopping The Engine	22
	● CRANE CONTROLS	
5.	MAIN WINCH/AUGER CONTROLS	23
6.	BOOM CONTROLS	25
7.	SWING CONTROLS	27
8.	TRAVEL CONTROLS; TRACKS EXTEND/RETRACT CONTROLS	29
9.	AUXILIARY WINCH CONTROL	31
10.	TOOL/AUGER OPERATION	33

APPENDICES

A. BOOM LOAD CHARTS35
B. MAINTENANCE CHART37
C. CAPACITIES & SPECIFICATIONS39
D. FILTER SPECIFICATIONS41
E. COLD WEATHER OPERATION43
F. REEVING DIAGRAM45
G. PREPARATION FOR SHIPPING47
H. COUNTERWEIGHT REMOVAL/INSTALLATION49
I. JIB/EXTENSION REMOVAL/INSTALLATION51
J. MAIN BOOM REMOVAL/INSTALLATION53
K. CRAWLER FRAME REMOVAL/INSTALLATION55
L. EXTENSION/JIB ERECTION & RIGGING57
M. TERMS & ABBREVIATIONS63

1. OVERVIEW

The Mantis 10010 is a diesel-powered, hydraulically-operated crawler crane. Its maximum load capacity is 45.3 metric tons (50 U.S. tons), depending on boom position and rigging.

The 10010 is operated from the crane operator's cab. This main operating station provides for operation and monitoring of all crane functions, including winch, boom, swing, and travel controls. All controls for normal crane operations are arranged in the standard configuration for crane operation.



DO NOT ATTEMPT TO OPERATE THIS EQUIPMENT UNTIL YOU READ AND FULLY UNDERSTAND ALL OF THE OPERATING INFORMATION IN THIS MANUAL.

FAILURE TO DO SO WILL CREATE A HAZARDOUS SITUATION THAT MAY RESULT IN SERIOUS INJURY, DEATH AND/OR EQUIPMENT DAMAGE.

Although the Mantis 10010 is simple to operate and care for, the operator must be thoroughly familiar with its operating controls and methods before starting any lifting work. Prior to operating the 10010, read and understand the information in this manual.

This machine uses a number of specialized controls and operator aids to enhance operation. Some of these devices may be unfamiliar to you. Your dealer, as part of his service, can explain any control or maintenance functions that are not clear.

The way you operate and maintain the Mantis 10010 for its first 100 hours will largely determine its useful life and freedom from unscheduled maintenance. This manual contains use and regular maintenance instructions for the 10010. Keep it handy, preferably in the operator's cab, and refer to it often.

MANUAL ORGANIZATION

This manual is organized as follows:

1. Overview - describes the 10010 in general, lists general cautions for safe crane operation, and explains the crane's systems and the way its documentation is organized.
2. Dash/Control Panels - describes the operator controls.
3. Load Moment Indicator/Anti-Two-Block Control - describes the controls of the LMI/A2B unit.
4. Engine - describes the startup and shutdown procedures and routine checks necessary to make sure the engine is operating properly and to keep it operating reliably.
5. Winch/Auger System - describes the operation of the lifting winch and proper hoisting procedures for the 10010.
6. Boom Controls - describes the operation of the boom up/down and telescope in/out systems.
7. Swing System - describes the swing system and its operation
8. Travel Controls - describes the operation of the 10010's travel controls.
9. Auxiliary Winch Control - describes the operation of the auxiliary winch system.
10. Tool/Auger Operation - describes the operation of the tool/auger hydraulic circuit controls.
11. Appendices - detail acceptable boom loads, routine maintenance, capacities and specifications, equipment filters, tips for proper operation in cold weather, diagram of crane reeving, proper procedures for mounting and removing counterweights, and a list of terms and abbreviations used in this manual.

OPERATOR ALERTS

This manual uses a number of alert levels to warn the operator about certain hazardous conditions. These alerts are listed below.

NOTE or WARNING

Indicates an operating or fault condition which may cause equipment damage if not corrected.



Indicates an operating or fault condition which is very likely to cause equipment or load damage.



Indicates a situation which will cause major equipment damage, operator injury, or death.

DIRECTIONAL REFERENCES

Crane Operations

When the words "right" and "left" designate direction in craning operations, they refer to the right- or left-hand side of the 10010 as viewed from the operator's cab, no matter which direction the cab is facing.

Travel Operations

When the words "right" and "left" designate direction in travel operations, they refer to the right- or left-hand side of the 10010 as viewed with the operator cab facing forward (boom over the idler end of the undercarriage). If the cab is facing backward (boom over the drive end of the undercarriage), all travel control functions are reversed.

Always use caution when using the 10010's travel controls as well as any other function.

CAPACITY LIMITS AND GENERAL CONDITIONS

The MANTIS 10010 Crane as manufactured by SpanDeck, Inc. meets the requirements of ANSI B30.5c (1992) when specifically equipped. Structure and stability have been tested in accordance with SAE J1063 and SAE J765, respectively. Lifting capacities as determined by boom length, angle, or lifting radius apply only to machines as originally equipped by the manufacturer and in a properly maintained condition.

Capacities given are maximum covered by the manufacturer's warranty and are based on a freely suspended load with no allowance for factors such as out-of-level operation, supporting surface conditions, hazardous surroundings, experience of personnel, etc.

The operator shall establish practical working loads based on prevailing operating conditions such as, but not limited to, those listed above.

When making lifts where capacities may be within a zone limited by structural strength, the operator shall determine that the weight of the load is known within $\pm 10\%$ before making the lift.

DO NOT lift a load without consulting the Load Chart. Deductions from rated capacities must be made for the weight of the hook block, overhaul ball, slings, spreader bar, or other suspended equipment.



DEATH BY ELECTROCUTION MAY RESULT UNLESS THE OPERATOR MAINTAINS A MINIMUM OF 10 FT (3.3 M) BETWEEN ANY PART OF THE CRANE OR LOAD AND ENERGIZED ELECTRICAL LINES OF 50KV OR LESS.

FOR CLEARANCE FROM LINES GREATER THAN 50KV, SEE SAFETY MANUAL.

ALWAYS ASSUME ANY LINE IS ENERGIZED.



SIDE PULL ON THE BOOM IS EXTREMELY DANGEROUS AND MUST BE AVOIDED.

DO NOT EXCEED THE MANUFACTURER'S SPECIFIED MAXIMUM REEVING.

Load radius is defined as the horizontal distance from the axis of rotation to the center of the lifting device after load is applied.

Boom angle is the included angle between the longitudinal axis of the boom base section and the horizontal axis, after lifting the load. The boom angle before lifting should be somewhat greater than desired to account for boom deflection.

Boom angle/boom length relationships given in the load charts are an approximation of the resulting load radius. The radius should be accurately measured.

Boom height dimensions are measured from ground to center of lower boom head sheave.

It is permissible to attempt to telescope the boom with a load within the limits of rated capacities. However, boom angle, system hydraulic pressure, and/or boom lubrication may affect operation.

The 10010 utilizes an LMI/A2B unit which monitors crane load, boom position and boom angle to determine whether the 10010 is operating within its limits. This unit also incorporates an "anti-two-block" control device to prevent the crane's lifting block from contacting the boom head sheaves. See Section 3, p.15, for details of LMI/A2B operation.

LUBRICATION AND MAINTENANCE

Proper and timely lubrication and service are essential for satisfactory performance of the 10010. Refer to the sections on lubrication and service in this manual.

Tighten all nuts, bolts, and hydraulic and electrical connectors on the 10010 after the first 100 hours of operation, then periodically reinspect them to make sure that everything remains tight.

At least once a month, do a thorough walk-around inspection of the crane. Finding and correcting minor problems before they become serious can prevent considerable downtime.

Protect against dirt - Before removing inspection covers, panels, filler caps, etc., from any part of the 10010, clean away all dirt around the opening. Keep all fuel and lubricants clean; use only fuel and lubricants that you know are clean. Keep all filler caps in place except when you are actually adding fluid and then replace them promptly.

If you experience any operating or service problems, contact your Mantis dealer or the factory immediately.

2. DASH/CONTROL PANELS

The 10010's operator controls are grouped into nine main functional groups as follows:

- Engine Controls
- Swing Right/Left Controls
- Telescope Out/In Control; Auxiliary Winch Control
- Main Winch Lower/Raise Control
- Boom Hoist Raise/Lower Control
- Travel Controls; Tracks Extend/Retract Switch
- Auxiliary Equipment Controls
- Other Operator Controls
- Load Moment Indicator/Anti-Two-Block System

The illustrations on this page show the layout of the 10010's control panels

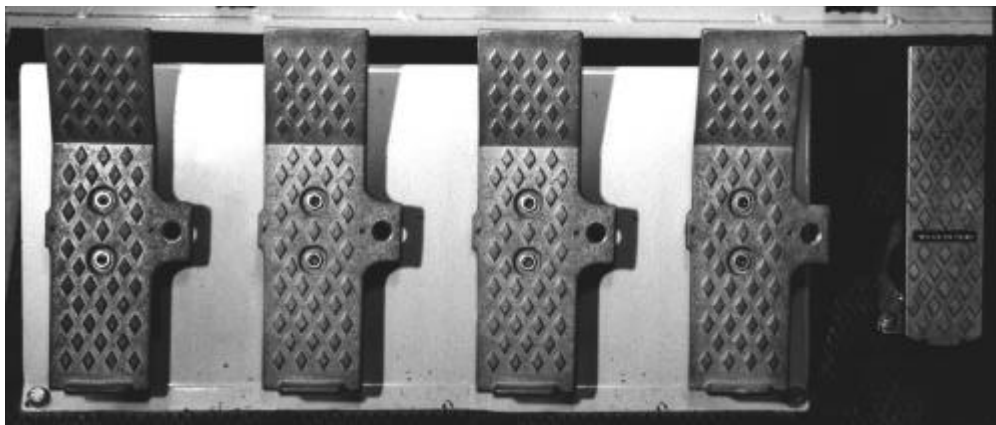
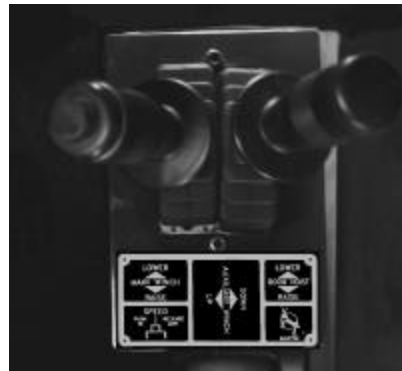

ENGINE CONTROLS

Voltmeter [1]

This gauge indicates the condition of the 10010's electrical system by displaying the battery voltage. Proper operation is indicated by a reading in the green zone (12-15 volts). Readings outside this range indicate a problem with one or more electrical system components.

Engine Hour Meter [2]

This meter displays cumulative engine running time in hours.

Oil Pressure Gauge [3]

This gauge indicates the engine oil pressure. Proper pressure may vary between 35 and 70 psi (2.4 and 4.8 bar) depending on engine and outside temperature, load, and engine speed.

Oil Pressure Warning Light [4]

This light illuminates to indicate that the engine oil pressure is too low. If this warning light comes on, the operator should stop the engine as soon as possible and determine the cause.

Engine Temperature Gauge [5]

This gauge indicates engine coolant temperature (water-cooled engines) or cylinder head or oil temperature (air-cooled engines).

For water-cooled engines, this gauge should read between 160 and 205°F (71 and 96°C) once the engine has reached operating temperature.

Readings outside this range indicate low coolant level (water-cooled engines only) or a problem with one or more cooling system components.

Engine Temperature Warning Light [6]

This light illuminates to indicate that the engine temperature is too high. If this warning light comes on, the operator should stop the engine as soon as possible and determine the cause.

Tachometer [7]

This gauge indicates engine rotation speed.

Fuel Level Gauge [8]

This gauge indicates the fuel remaining in the 10010's fuel tank.

Ignition Off/Operation/Preheat/Start Switch [9]

This key-operated rotary switch controls starting and stopping of the engine. See Engine Operation, P.17, for starting and stopping instructions.

Hand Throttle [10]

This rotary knob sets a constant engine speed; rotating the knob counterclockwise increases engine speed. The operator may tighten the locking ring at the base of the control to keep engine speed constant. Pressing the red button on top of the throttle returns the engine to idle speed without rotating the knob.

Foot Throttle [11]

This pedal controls engine speed; pushing the pedal down increases speed, releasing it decreases speed. This control can override the setting of the Hand Throttle if the operator wishes to temporarily speed up the engine.

See Engine Operation, P.17, for guidelines on proper engine speeds under various operating conditions.

Air Filter Warning Light [12]

This light illuminates to indicate that engine combustion air flow is restricted and the filter needs to be serviced.

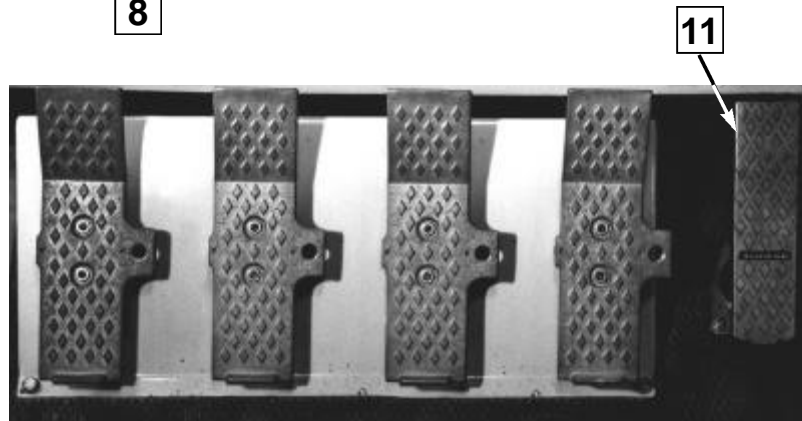
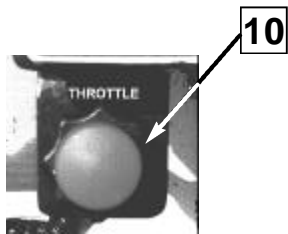
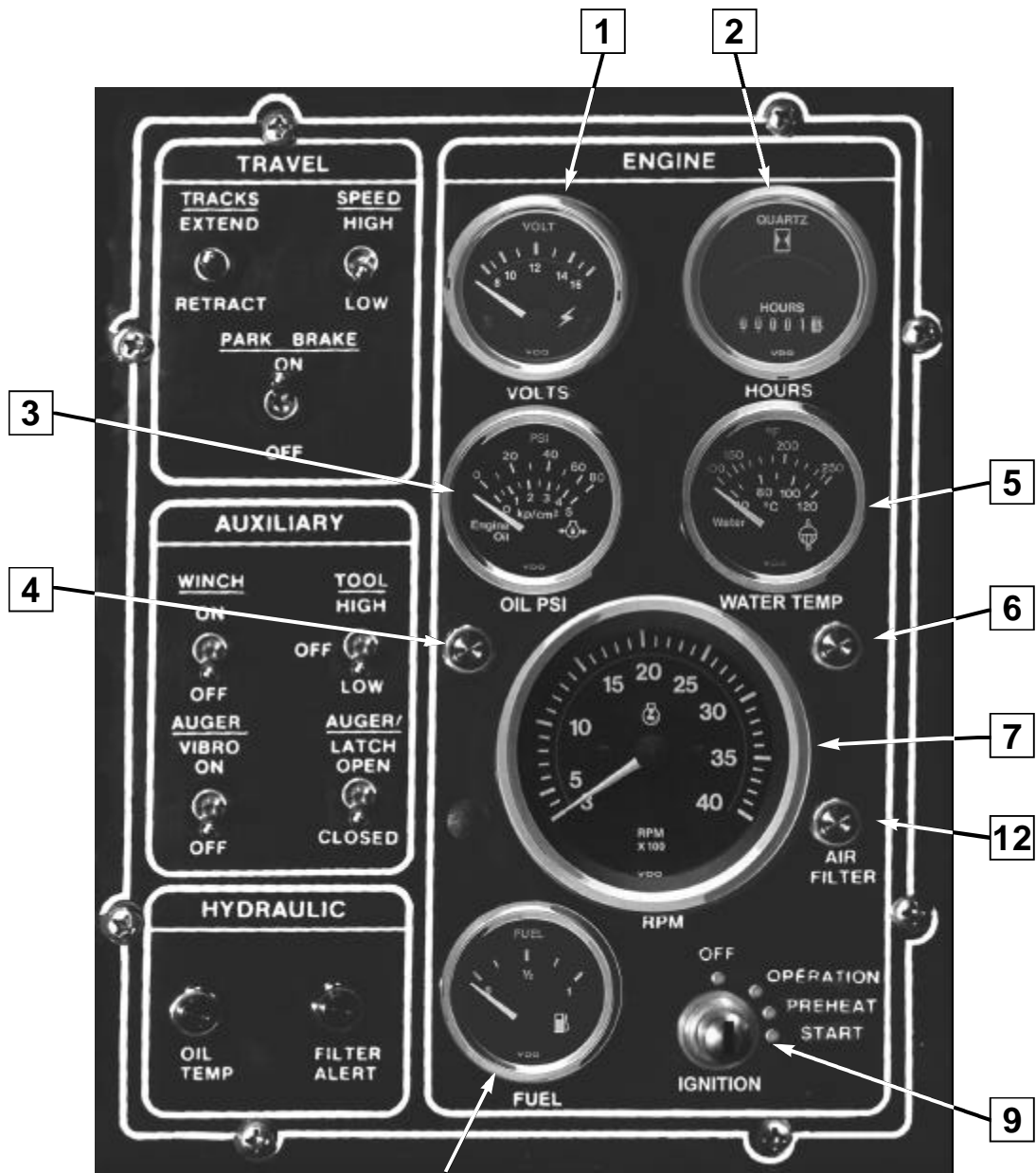

SWING RIGHT/LEFT CONTROLS

NOTE:

Speed of operation of the Swing System is directly proportional to engine speed and control lever displacement

Swing Control/Horn Button 1

This lever controls the Boom Swing function. Pushing the lever forward swings the boom right and pulling it backward swings the boom left.

The button at the top of this control lever sounds the warning horn when depressed.

Swing Brake Pedal 2

This pedal engages the swing brake when pushed forward (toe down) and releases it when the pedal is released.



DO NOT REST YOUR FOOT ON THE SWING BRAKE PEDAL.

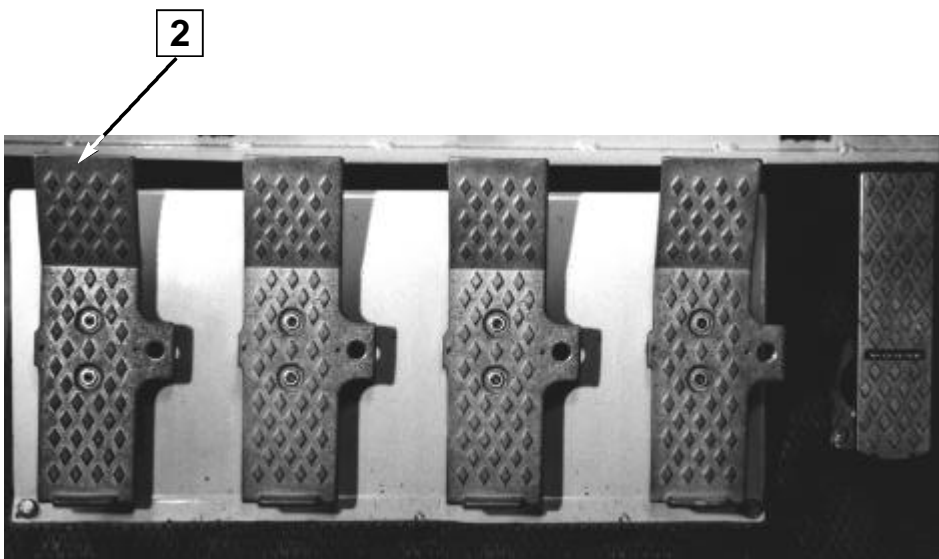

Swing Brake Switch 3

This toggle switch engages (ON) or disengages (OFF) the swing park brake.



NEVER ENGAGE THE SWING PARK BRAKE WHEN THE SWING IS IN MOTION.

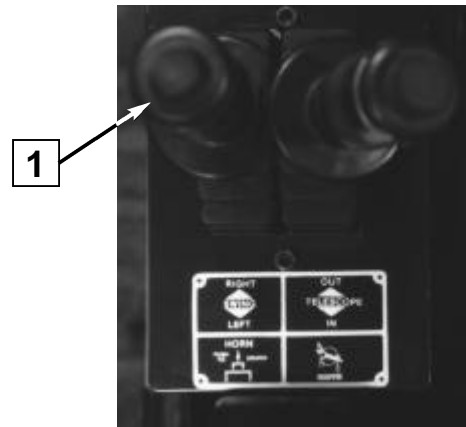

TELESCOPE OUT/IN CONTROL

Boom Telescope Control Lever 1

For cranes *not* equipped with the optional auxiliary winch, this lever controls the boom telescope function; pushing it forward extends the boom and pulling it backward retracts the boom.

Boom Telescope Pedal 2

NOTE:

This pedal is not present on cranes without the auxiliary winch option.

For cranes equipped with the optional auxiliary winch, this pedal controls the boom telescope function; pushing it forward (toe down) extends the boom and pushing it backward (heel down) retracts the boom.

BOOM HOIST CONTROL

Boom Hoist Raise/Lower Control Lever 3

This lever controls the Boom Hoist function. Pushing the lever forward lowers the boom; pulling it backward raises the boom.

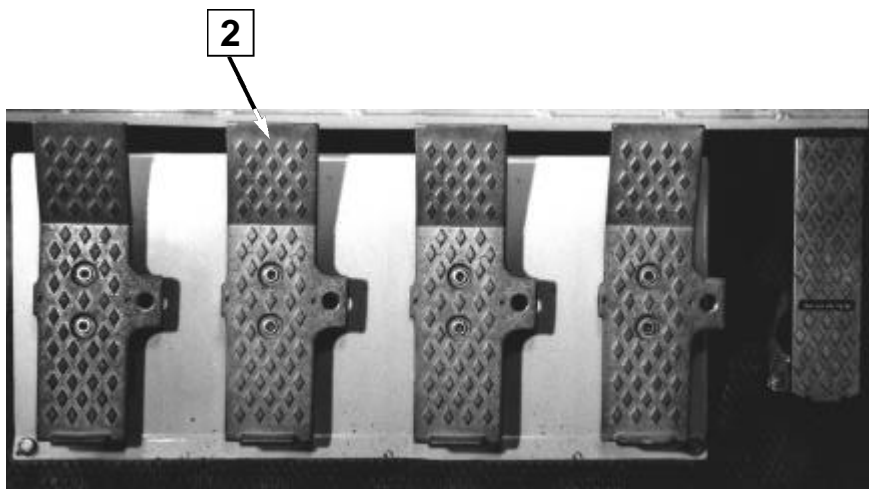
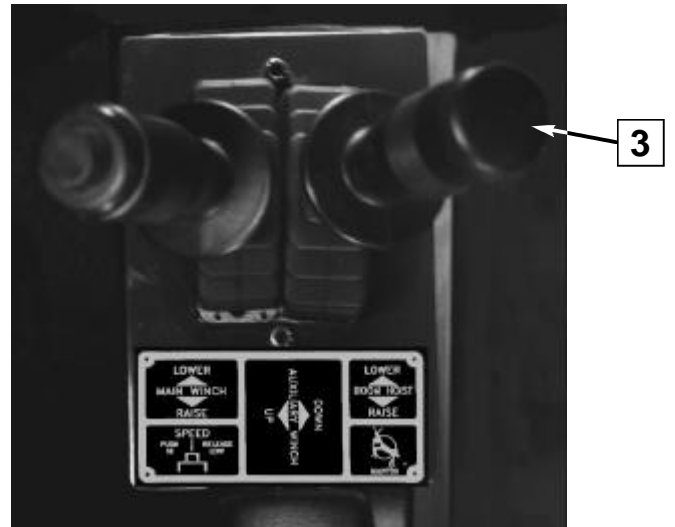
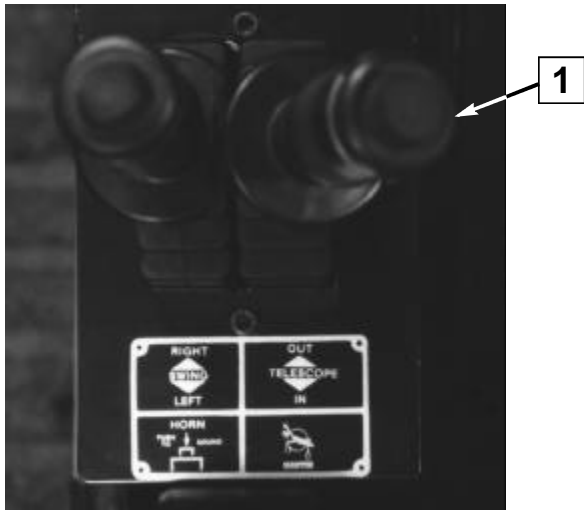

MAIN WINCH/AUXILIARY WINCH CONTROLS

A four-way joystick control operates both the main and auxiliary winches; forward/backward movement operates the main winch, and side-to-side movement operates the auxiliary winch.

NOTE:

Speed of operation of the Winch Controls is directly proportional to engine speed and control lever displacement.

Main Winch/Auger Control 1

When the AUGER/VIBRO On/Off switch (See *Auxiliary Equipment Controls*, P.12) is off, forward/backward movement of the four-way joystick controls the main winch. Pushing it forward lowers the hook block and pulling it backward raises the block.

Speed Range Button 2

This button, at the top of the Main Winch/Auger Control lever, selects either the low (button not depressed) or high (button depressed) range of main winch rotation speed.

Auxiliary Winch Control 3

Side-to-side movement of the four-way joystick controls the auxiliary winch. Pushing it rightward lowers the hook block and pushing it leftward raises the hook block.

Winch Speed High/Low Switch 4

This toggle switch selects either high or low range of auxiliary winch rotation speed.

Using Both Winches Together

By moving the lever diagonally (at an angle), the operator can run both winches at the same time. The speed of each winch will be proportional to the lever movement in the direction which controls that winch.



BOTH WINCHES ARE ACTIVE WHENEVER THE ENGINE IS RUNNING. ANY CONTROL LEVER MOTION, WHETHER INTENDED OR NOT, WILL CAUSE WINCH ROTATION AND LOAD MOVEMENT.

BE CAREFUL TO PUSH THE JOYSTICK ONLY IN THE DIRECTION WHICH OPERATES THE WINCH(ES) PROPERLY.

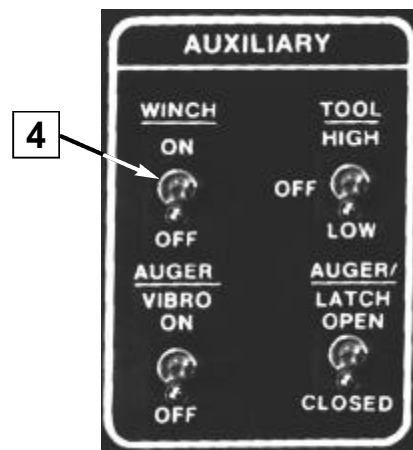
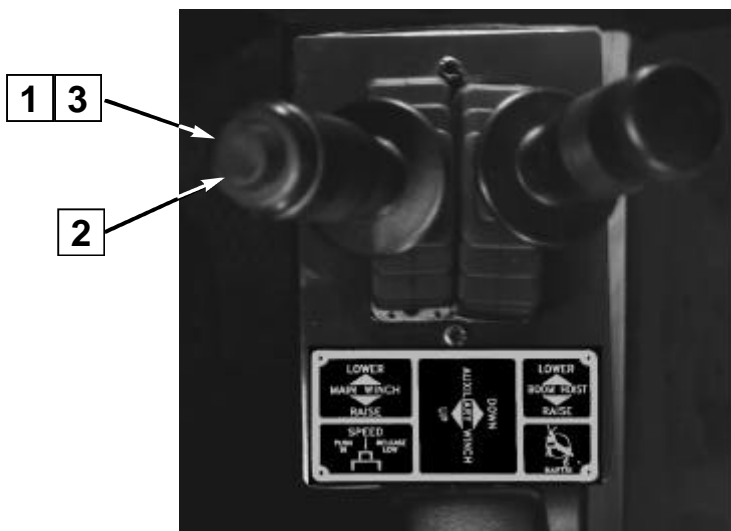

TRAVEL CONTROLS

Left¹/Right² Track Forward/ Track Reverse Pedals

These pedals control the track motion. Pushing either right or left pedal forward (toe down) moves its track forward; pushing either pedal backward (heel down) moves its track backward.

Travel speed is proportional to engine speed and pedal displacement.

Speed High/Low Switch ³

This toggle switch selects either high (2.2 mph, 3.5 km/h) or low (1.3 mph, 2.1 km/h) travel speed.

Park Brake On/Off Switch ⁴

This toggle switch engages (for crane operation) or disengages (for crane travel) the travel brake.



OPERATOR CAB ORIENTATION AFFECTS THE OPERATION OF THE TRAVEL FUNCTIONS. SEE DIRECTIONAL REFERENCES, P.2.

TRACKS EXTEND/RETRACT SWITCH ⁵

This toggle switch controls the position of the crane's tracks. The switch is spring-loaded to the center position. When the switch is pushed toward extend, the tracks move to their wide (18.75 ft, 5.72 m*) configuration for lifting. When it is pushed toward retract, the tracks move to their narrow (12.42 ft, 3.79 m*) configuration for travel or transport.



NEVER LIFT LOADS WITH THE 10010 UNLESS THE TRACKS ARE FULLY EXTENDED. (UNLESS SPECIFICALLY ALLOWED BY A "TRACKS RETRACTED LOAD CHART.")



THE OPERATOR MUST ENSURE THAT NO PERSONNEL ARE NEAR THE 10010'S TRACKS BEFORE ENGAGING THE TRACKS EXTEND FUNCTION.

* Overall widths listed above are for the 10010 as equipped with 30" (0.76m) tracks. Fitting wider or narrower tracks will change these dimensions.

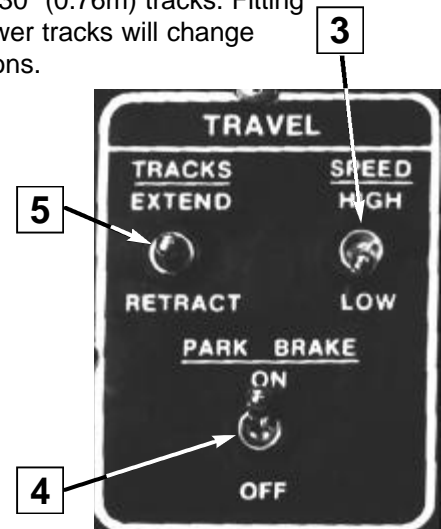
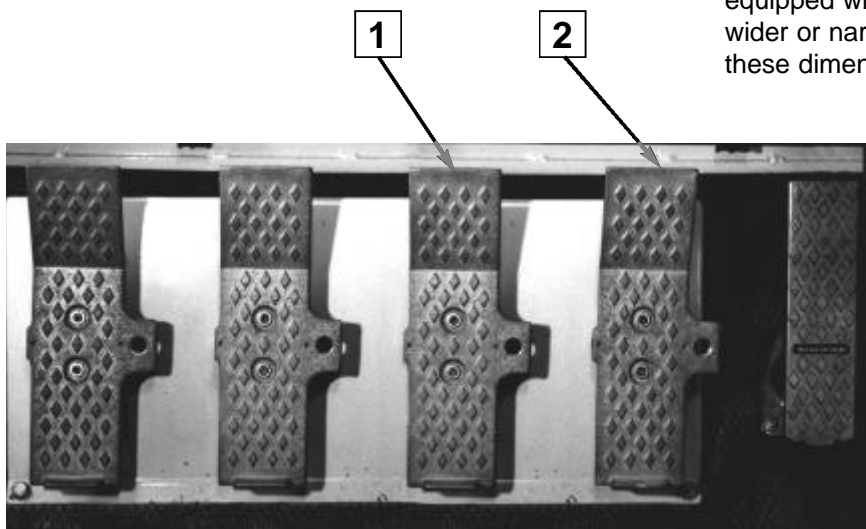

AUXILIARY EQUIPMENT CONTROLS

Tool High/Off/Low Switch (Option) 1

This toggle switch selects either high (37.8 l/min, 10 GPM) or low (18.9 l/min, 5 GPM) hydraulic fluid volume for the optional tool connector ports or turns the ports off.

Auger/Vibro On/Off Switch (Option) 2

This toggle switch turns pressure to the auger/vibro connection ports on or off to control auger/vibro operation.

Main Winch/Auger Control 3

When the AUGER/VIBRO switch is on, this lever controls auger operation: pushing it forward rotates the auger forward and pulling it backward rotates the auger in reverse.

Speed Range Button 4

This button, at the top of the Main Winch/Auger Control lever, selects either the low (button not depressed) or high (button depressed) range of auger rotation speed.

For cranes equipped with the optional “Thumb Thumper” indicators for winch rotation (see P.10), auger speed range is selected by the Auxiliary Winch Speed Range switch located on the lower panel of the left-side operator console.

If the 10010 is equipped with a vibro hammer instead of an auger, the speed range button or switch has no function when the AUGER/VIBRO switch is on.

Auger Latch Open/Closed Switch (Option) 5

This toggle switch engages or disengages the latch that holds the auger in stowed position.

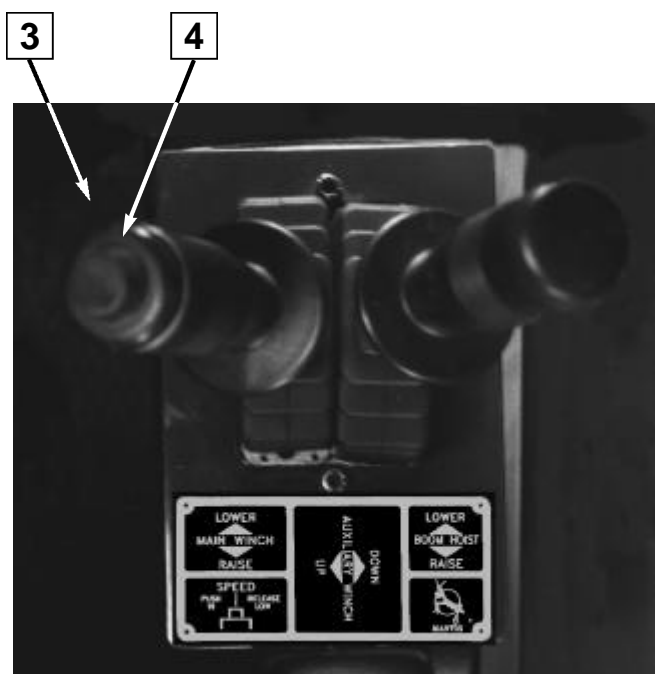
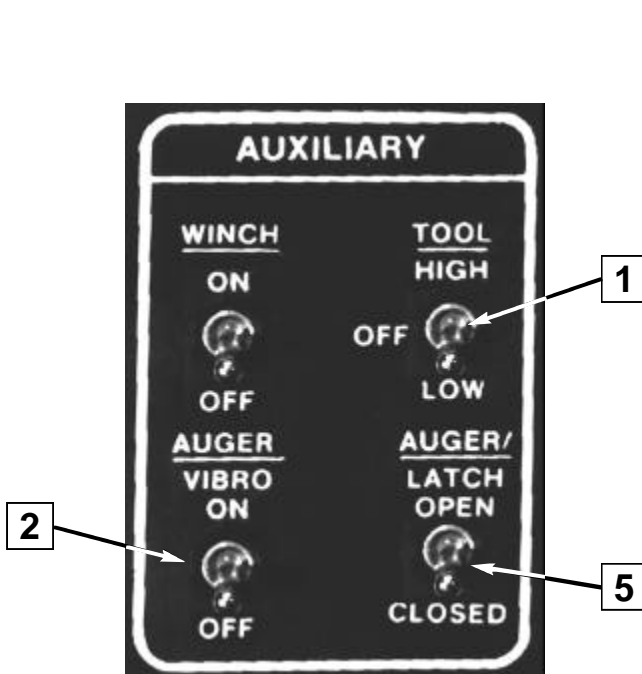

OTHER OPERATOR CONTROLS

Level Gauge ¹

This is a dual-bubble device which allows the operator to determine whether the 10010 is level in both front-rear and left-right directions.



ANY OUT-OF-LEVEL CONDITION WILL AFFECT THE 10010'S LIFTING CAPACITY. SEE APPENDIX A, BOOM LOAD CHARTS FOR DETAILS.

Warning Light Test Switch ²

This button, when pushed with the engine running, illuminates all of the operator panel warning lights to check their function. The operator should check all warning lights each time he starts the engine.

Fuel Filter/Water Separator

Warning Light ³

The warning light in this unit illuminates to indicate that the water separator is nearly full and needs service.

Hydraulic Oil Temperature/ Filter Alert Lights ⁴

These warning lights illuminate to warn the operator that the hydraulic oil is too hot or that the filter has become clogged. Either condition signals the operator to cease lifting operations as quickly as possible and to find and correct the problem.

Hydraulic Cooling System

Auto/Manual Switch ⁵

This switch selects between thermostatically-controlled (**AUTO**) or continuous (**MANUAL**) operation of the hydraulic cooling system. Under normal operation, this switch should be left in Auto. However, the operator may override this automatic operation at any time by switching to Manual.

Circulating Fan Hi/Off/Low Switch ⁶

This toggle switch selects high or low speed operation of the circulating fan motor or turns it off.

Heater Fan Off/Low/Hi Switch ⁷

This rotary switch selects high or low speed operation of the heater blower motor or turns it off.

Defrost On/Off Switch ⁸

This toggle switch turns the defrost blower motor on or off.

Heat Control ⁹

This push-pull control adjusts the temperature of the air circulated by the heater fan. Pulling the knob out raises the temperature; pushing it in lowers the temperature.

Windshield Wiper Control ¹⁰

This rotary switch selects low or high speed operation of the windshield wiper or turns it off.

Battery Cutoff Switch ¹¹

This switch, located in the battery compartment, selects the connection between the 10010's batteries and electrical system. The operator may connect or disconnect either or both batteries.

For normal operation, both batteries should be connected. Whenever the crane is left unattended, the operator should turn this switch to off and lock it in this position.

CONTROL LAYOUT SHOWN ON NEXT PAGE

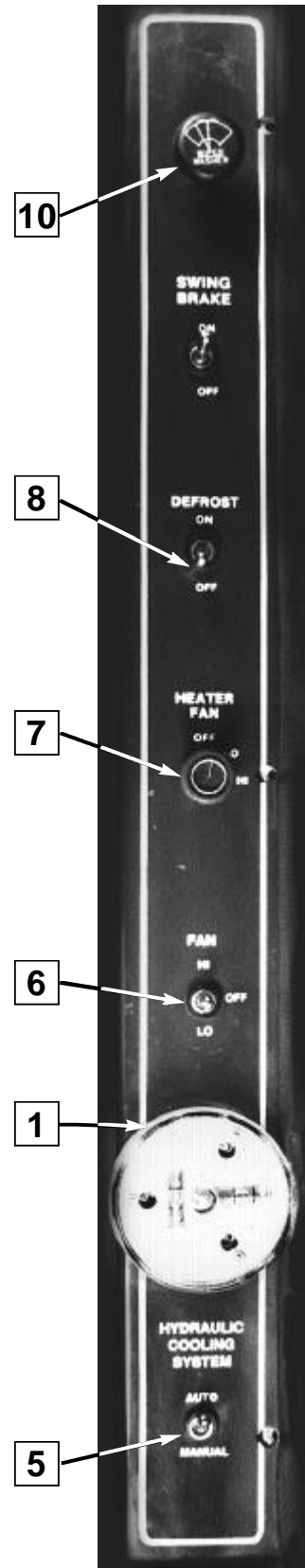
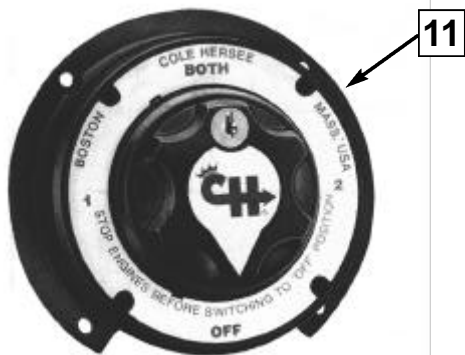
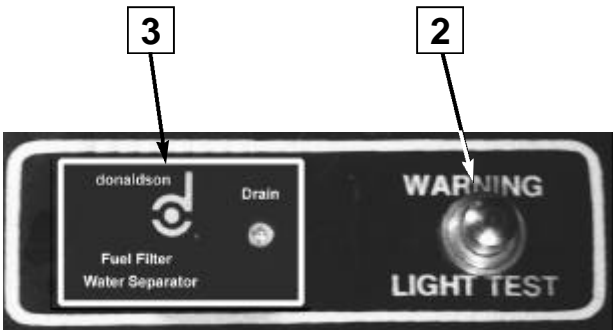
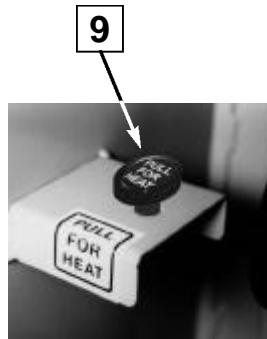
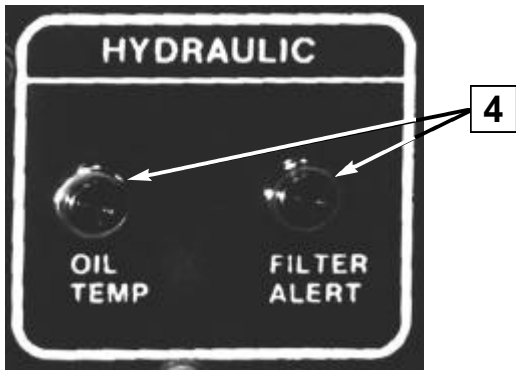

3. LOAD MOMENT INDICATOR/ ANTI-TWO-BLOCK (LMI/A2B) SYSTEM



THE LMI/A2B IS AN OPERATIONAL AID THAT WARNS THE CRANE OPERATOR OF APPROACHING OVERLOAD CONDITIONS AND ALSO WARNS OF OVERHOIST CONDITIONS WHICH COULD CAUSE DAMAGE TO EQUIPMENT AND INJURY TO PERSONNEL.

THE DEVICE IS NOT, AND SHALL NOT BE, A SUBSTITUTE FOR GOOD OPERATOR JUDGMENT, EXPERIENCE, AND THE USE OF ACCEPTED CRANE OPERATING PROCEDURES.

THE RESPONSIBILITY FOR THE SAFE OPERATION OF THE CRANE SHALL REMAIN WITH THE CRANE OPERATOR, WHO SHALL ENSURE THAT HE UNDERSTANDS AND OBSERVES ALL SUPPLIED WARNINGS AND INSTRUCTIONS.

PRIOR TO OPERATING THE CRANE, THE OPERATOR MUST CAREFULLY AND THOROUGHLY READ AND UNDERSTAND THE INFORMATION IN THIS MANUAL TO ENSURE THAT HE KNOWS THE OPERATION AND LIMITATIONS OF THE LMI/A2B SYSTEM AND CRANE.

PROPER FUNCTIONING IS DEPENDENT UPON PROPER DAILY INSPECTIONS AND UPON OBSERVATION OF THE OPERATING INSTRUCTIONS SET FORTH IN THE LMI/A2B MANUAL.

The Mantis 10010 is equipped with a Load Moment Indicator (LMI)/Anti-Two-Block (A2B) system which aids the operator in preventing overload and two-block conditions. The system is factory set and no adjustments can be made to it by unauthorized personnel.

The LMI/A2B unit is programmed with load charts installed in the machine during load testing at the factory. Before making a lift, the operator must select the proper operating mode and set the reeving switch to the appropriate "parts of line." See Appendix A and the LMI/A2B System Operator's Manual for details.

LOAD MOMENT INDICATOR (LMI)

Boom length and angle are determined by the boom-mounted reel which contains the length and angle transducers. Based on these factors, the system computer determines load radius which is displayed in the operator cab.

Pressure transducers connected to the boom hoist cylinder determine boom load by reading the hydraulic pressure in the cylinder. The system calculates the "load-moment" based on load and load radius and alerts the operator if an overload situation is approaching.

In case of emergency or component failure, the operator can override the system by turning the console-mounted key switch in the operator cab.

LOAD CHART SELECTION & LOAD MOMENT INDICATOR SETTING

Each Load Chart in Appendix A corresponds to a particular crane configuration. The Load Moment Indicator system must be set to match the configuration in use. If it is set improperly, the crane may function poorly or not at all.

The LMI has three switches that correspond to critical setup factors, as follows:

Counterweight Toggle Switch

This side-mounted switch selects whether or not the crane is using a counterweight.

Operating Code Decade Switch

This rotary switch selects the crane operating mode, or boom configuration.

Reeving Switch

This switch is set to match the reeving used on the crane. The correct number of parts of line must appear under the window of the control knob.

The chart in Appendix A shows the permissible combinations of settings for these three switches, as well as the proper load charts to use for each mode. No other combinations are allowed.

NOTE:

If you are certain that a load is within load chart limits but the crane will not lift it, check the settings of these three switches.

ANTI-TWO-BLOCK (A2B)

The anti-two-block feature aids the operator in preventing the hook block from contacting the point sheaves (a "two-block" situation). This system will stop the function(s) being used at the time the block contacts and lifts the A2B switch weight.

The system consists of switches mounted at the boom tip and single sheave stand-off (Rooster), extension tip, or jib tip (if used). The switch(es) support a weight through which the load line passes.

When the hook block or headache ball lifts this weight, the switch contacts close sending a signal to a solenoid valve. When the solenoid valve receives the signal, it shifts to divert the control pressure for boom lower, boom extend and winch raise circuits, stopping the functions until the two-block situation is cleared.

As with the LMI system, in case of component failure, the operator can override the system with the console-mounted key switch in the operator cab.

The crane operator must read the LMI/A2B System Operator's Manual before operating the system. In case of a problem, the system console will display an error code. The operator must then consult the Troubleshooting Manual, and if unable to rectify the problem, call the factory or a Mantis dealer for assistance.

Both the Operator's Manual and Troubleshooting Manual for the LMI/A2B are included in the documentation package provided with this equipment.



PAT DS-150 OPERATING CONTROLS

See the LMI/A2B System Operator's Manual for complete control descriptions

- | | |
|--|----------------------------------|
| 1. Display | 9. INFO Button |
| 2. Load Moment Indicator Bar Graph | 10. Angle Limit Button |
| 3. Counterweight Toggle Switch | 11. E Button |
| 4. Reeving Switch | 12. Key Switch |
| 5. Anti-Two-Block Alarm Light | 13. A2B Bypass Switch Position |
| 6. Load Moment Prewarning Light | 14. Normal Operation Position |
| 7. Load Moment Alarm Light and Horn Off Button | 15. LMI Bypass Position |
| 8. Load Indication Button | 16. Audible Alarm |
| | 17. Operating Code Decade Switch |

4. ENGINE OPERATION

ALARM SYSTEMS

The Mantis 10010 uses either the Caterpillar 3116 or the Cummins 6C-8.3l diesel engine with an integral hydraulic pump to provide power for all machine functions. This engine incorporates a number of alarm systems to protect the engine from abnormal operating conditions.

The alarm systems provide a visual warning to signal the operator that an abnormal operating condition exists.

Alarms are triggered by low oil pressure or high coolant temperature. Each alarm will continue until the cause of the alarm condition is corrected.

See Section 2, Dash/Control Panels for a description of the 10010's engine alarms.

WALK-AROUND INSPECTION

For maximum service life of your engine, make a thorough inspection before starting the engine. Look for such items as oil or coolant leaks, loose fasteners, worn fan belts, and trash build-up. Remove trash build-up and have repairs made as needed.

Perform required periodic maintenance before starting the engine. Make a walk-around inspection of the equipment. A few minutes spent making minor corrections can prevent major repairs later.

NOTE:

Accumulated grease and oil on an engine or platform is a fire hazard. Remove this debris with steam cleaning or high pressure water at least monthly or whenever any significant quantity of oil (or other fluid) is spilled on or near an engine and working area.

Wipe fittings, caps, and plugs clean before servicing.

Air Intake System

- Observe the dash-mounted Air Filter Warning Light. Service the air cleaner when the light comes on.
- Inspect the air intake system hoses, piping, elbows and gaskets for cracks or damage. Replace items as needed. Check for loose clamps and tighten if necessary.

Water-Cooled Engine Cooling System

- Inspect the cooling system for leaks and trash build-up. Clean any accumulation with compressed air or high-pressure water.
- Inspect the water pump for leaks.

NOTE:

The water pump seal is lubricated by the engine coolant. A small amount of leakage as the engine cools down and parts contract is acceptable.

- Inspect the system hoses and crankcase breather hose for cracks and loose clamps.
- Inspect the fan and accessory drive belts for cracks, breaks, or other damage. Check for proper belt tension.

Air-Cooled Engine Cooling System

- Check all air flow paths for collection of debris that can block air flow. Clean any accumulation with compressed air or high-pressure water.



DO NOT SPRAY WATER ON A HOT ENGINE.

- Inspect the fan and accessory drive belts for cracks, breaks, or other damage. Check for proper belt tension.

Electrical System

Wiring must be kept in good condition, properly routed and firmly attached. Routinely inspect wiring for wear or deterioration. Loose connectors or dangling wiring must be tightened or reattached. Do not bypass fuses.

Tight connections and properly maintained cables will help prevent sparking that could cause a fire.

- Inspect the engine-to-frame rail ground strap for good connection and condition.
- Check the battery and battery cables for poor connections and corrosion.

Fuel and Lube Systems

- Make sure fuel lines are properly clamped and tight. Check for loose fittings or leaks.
- Drain water from the water separator.
- Check for lubrication leaks at areas such as the front and rear crankshaft seals, crankcase, oil filter, oil gallery plugs, sensors, and valve covers.

NOTE:

If you observe leaking fluid, find the source and correct the leak. If you suspect a fluid leak, check the fluid levels more frequently than the recommended service intervals until you either find a leak or prove to your satisfaction that there is no leak.

Pre-Start Checks

- All guards must be in place. Repair or replace all guards that are damaged or missing.
- Measure the engine crankcase oil level. The correct oil level is between the High (H) and Low (L) marks on the dipstick. Oil capacity from the low to high marks is 1.9l (2.0 US quarts).

NOTE:

Make sure the crane is level when checking the engine oil level.

- Check the oil level(s) on driven equipment.

For water-cooled engines only:

- Check the coolant level with the engine stopped and cold. Remove the filler cap slowly to relieve pressure gradually.
- Maintain the coolant level to within 13 mm ($\frac{1}{2}$ in) of the bottom of the fill pipe. Install the filler cap.

NOTE:

To prevent engine damage, never add coolant to an overheated engine. Allow the engine to cool first.

- After starting, operate the engine at slow speed until it reaches operating temperature. Check the coolant level and add coolant if necessary. Check for any obvious cooling system leaks or loose connections. Inspect the water pump for evidence of leaks.
- Disconnect any battery chargers that are not protected against the high current drain created when the electric starter engages.

WARNING:

Diesel engine exhaust contains products of combustion which may be harmful to your health. Always start and operate the engine in a well ventilated area, and, if in an enclosed space, vent the exhaust to the outside.

Do not start the engine or move any of the controls if there is a "DO NOT OPERATE" or similar warning tag attached to the start switch or controls.

The operator must be satisfied that no one will be endangered before starting the engine.

If the engine has not been run for several weeks, fuel may have drained and allowed air into the filter housing. Also, when fuel filters have been changed, some air space will be left in the housing.

In these instances, prime the fuel system.

NOTE:

Do not engage the starter when the engine is turning.

Do not start the engine under load.

For starting below -18°C (0°F), use of optional cold weather starting aids is recommended. A coolant heater or extra battery capacity may be required.

For temperature below -23°C (-10°F), consult your local diesel engine dealer.

ELECTRIC STARTING

NOTE:

Starting ability will be improved at temperatures below 16°C (60°F) by the use of a starting aid and/or use of a jacket water (coolant) heater or other means to heat the cylinder block.

Start the engine using the following procedure:

1. Make sure that all hydraulic control levers are in their neutral positions.
2. Turn the starter switch to the START position. Crank the engine. Release the switch as soon as the engine starts.

NOTE:

Do not crank the engine for more than 30 seconds. Allow the starter to cool for two minutes before cranking again.

Turbocharger damage can result if the engine rpm is not kept low until the engine oil light or gauge verifies the oil pressure is sufficient.

Consult the engine operating manual for complete details on proper operating speeds.

If the engine does not start readily, especially at ambient temperatures below 16°C (60°F), use the Starting Aid pushbutton (if equipped) to inject starting fluid. While cranking the engine, depress and hold the Starting Aid switch for 3 seconds.

At temperatures below 0°C (32°F), you may need to spray additional starting fluid directly into the air cleaner inlet.

Additional injections of ether may also be required to achieve a low idle speed.

WARNING:

When using starting fluid, follow the manufacturer's instructions carefully and use it sparingly. Failure to do so could result in explosion and/or fire and possible personal injury.

NOTE:

Excessive ether can cause piston and ring damage. Use ether for cold starting purposes only. Do not use excessive starting fluid during starting or after the engine is running.

If the engine fails to start within 30 seconds, release the starter switch and wait two minutes to allow the starter motor to cool before using it again.

3. Once the engine starts, allow it to run at low idle speed for three to five minutes, or until the engine temperature gauge indicator has begun to rise. Increase engine speed to high idle only after the engine is running smoothly at low idle.
4. Allow the white smoke to clear up and proceed with normal operation. Do not apply load to the engine or increase engine speed until the oil pressure gauge indicates normal. Oil pressure should rise within 15 seconds after the engine starts.

NOTE:

If oil pressure does not rise within 15 seconds after the engine starts, stop the engine and follow necessary troubleshooting procedures before restarting.

5. Operate the engine at low load and rpm until the engine temperature is within its normal range. Monitor all gauge readings during this warm-up period.

STARTING WITH JUMPER CABLES

WARNING:

Batteries give off flammable fumes that can explode.

Improper jumper cable connections can cause an explosion resulting in personal injury.

Prevent sparks near the batteries. Sparks could cause vapors to explode. Do not allow jumper cable ends to contact each other or the engine.

Do not smoke when observing the battery electrolyte levels.

Always wear protective glasses when working with batteries.

Electrolyte is an acid and can cause personal injury if it contacts skin or eyes.

Engines installed without separate engine-to-frame rail ground straps can be damaged by electrical discharge.

To prevent electrical discharge damage, check to make sure the engine's electrical system has a separate engine-to-frame rail ground strap. For engines which have the alternator connected to an engine component, the ground strap must connect that component to the frame.

Some engines have starter-to-frame ground straps, but many of these starters are not electrically grounded to the engine. They have electrical insulation systems. For this reason, the starter-to-frame ground strap may not be an acceptable engine ground.

When boost starting, refer to the instructions that follow to properly start the engine.

NOTE:

When using an external electrical source to start your engine, turn the START switch OFF and turn off all electrical accessories before attaching cables.

Your engine may be equipped with a 12 or 24 volt starting system. Use only the same voltage for boost starting. Use of a welder or higher voltage will damage the electrical system.

When using jumper cables, always connect POSITIVE (+) cable to POSITIVE (+) battery terminal which is connected to starter solenoid and NEGATIVE (-) cable from external source to starter NEGATIVE (-) terminal. If not equipped with a starter NEGATIVE terminal, connect to the engine block.

Do not reverse the battery cables. The alternator can be damaged.

Attach the ground cable last and remove it first.

1. Connect one end of the cable to the POSITIVE (+) terminal of the battery being started. Connect the other end to the POSITIVE (+) terminal of the power source.
2. Connect one end of the other cable to the NEGATIVE (-) terminal of the power source. Connect the other end to the starter NEGATIVE (-) terminal or to the engine block. This prevents potential sparks from igniting combustible gases produced by some batteries.
3. Begin cranking engine to start and achieve idle speed.
4. After the engine starts, disconnect the cable from the starter NEGATIVE (-) terminal or engine block. Disconnect the other end from the NEGATIVE (-) terminal of the power source.
5. Disconnect the cable from the POSITIVE (+) terminal of the battery on the engine being started. Disconnect the cable from the POSITIVE (+) terminal of the power source.

AFTER STARTING THE ENGINE

As soon as the engine starts, release the starter switch and reduce rpm to low idle.

NOTE:

Keep engine speed low until the engine oil pressure registers on the gauge or the engine oil light goes out. If the gauge does not register or the light does not go out within fifteen seconds, stop the engine and investigate the cause before starting again. Failure to do so can cause engine damage.

Allow a cold engine to warm up at LOW IDLE for at least five minutes. Do not apply load to the engine or increase engine rpm until the oil pressure gauge indicates normal.

When idling the engine for warm up, observe the following recommendations:

- In temperatures above 0° C (32° F), warm-up requires approximately 15 minutes.
- In temperatures below 0° C (32° F), warm-up requires approximately 30 minutes or more.
- In temperatures below -18° C (0° F), warm-up requires more than 30 minutes.

Operate the engine at low load and rpm until the engine temperature reaches its normal operating range. Check all gauges during the warmup period.

After the engine is started and the cold idle operation is completed, the engine can be operated at low speed and low power. The engine will reach normal operating temperature faster when operated at low speed and low power demand than when idled at no load.

Maximum no-load speed for a warm engine is 2500 rpm. Exceeding this limit may cause severe engine damage.

Check all gauges and warning lights frequently during operation.

ENGINE STOPPING

NOTE:

Stopping the engine immediately after it has been working under load can result in overheating and accelerated wear of the engine components. Follow the stopping procedure outlined below to allow the engine to cool. Excessive temperatures in the turbocharger center housing could cause oil coking problems.

Make sure that you understand the Engine Stopping procedure before operating the engine.

Manual Stop Procedure

1. Reduce engine speed to LOW IDLE.
2. Remove load from engine by ceasing all hydraulic-powered operations.
3. Increase engine speed to no more than half Full Load (rpm) speed for two minutes to cool the engine.
4. Reduce engine speed to low idle for five minutes to cool the engine and prevent oil coking problems in the turbocharger center housing.
5. Stop the engine by turning the Ignition Switch to Off.

AFTER STOPPING THE ENGINE

1. After the engine cools, fill the fuel tank to prevent accumulation of moisture in the fuel.

Water-cooled engines only:

2. Maintain the cooling system to 13 mm ($\frac{1}{2}$ inch) from bottom of the fill pipe.

If you expect freezing temperatures, allow the engine jacket water cooling system to cool, then check the coolant for proper antifreeze protection. The system must be protected against freezing to the lowest expected outside temperature.

Add a coolant mix of antifreeze and water. Refer to Appendix C of this manual for information about acceptable water and antifreeze concentrations.

3. Check the engine crankcase oil level. The correct oil level is between the High (H) and Low (L) marks on the dipstick. Oil capacity from the low to high marks is 1.9l (2.0 US quarts).

NOTE:

Make sure the crane is level when checking the engine oil level.

Always wait at least five minutes after shutting off the engine before checking the oil level to allow oil to drain back into the oil pan.

4. Repair any leaks, perform minor adjustments, tighten loose bolts, etc.
5. Observe the service meter reading. Perform periodic maintenance as indicated in Appendix B, Maintenance Chart.
6. If the crane will be left unattended for an extended period of time (overnight or over a weekend, for example), turn off and lock the Battery Cutoff Switch (P.13). This will help prevent unauthorized use of the crane and/or accidental battery discharge.

5. MAIN WINCH/AUGER CONTROLS

Mounted at the left (inside) position of the right hand seat-mounted console is the control lever for the main winch raise/lower function. The main winch system consists of a manifold-mounted directional control valve that routes oil to the 2-speed winch motor causing the motor to rotate in the desired direction. The winch is equipped with an integral spring-applied, hydraulically-released disc brake that holds the load in position. Pressure applied to the brake valve unlocks the brake allowing the load to be lowered.

WINCH OPERATION

To raise a load, the control lever is pulled rearward; to lower a load, the control lever is pushed forward. As with all other functions, speed is directly proportional to engine speed and control displacement.

A momentary pushbutton located on top of the winch control lever actuates the winch speed shifter valve. Pressing and holding the button selects high speed; releasing it selects low speed. The winch may be shifted from high to low or from low to high at any time during operation.

If the crane is equipped with the optional “Thumb Thumper” indicators for winch rotation, this button vibrates whenever the auxiliary winch is rotating. When so equipped, auxiliary winch speed range is selected by the Main Winch Speed Range switch located on the lower panel of the right-side operator console.



DO NOT OPERATE THE WINCH IN HIGH SPEED IN THE LOWERING DIRECTION WITH A HEAVY LOAD DUE TO THE POSSIBILITY OF “OVER-RUNNING” THE MOTOR AND CAUSING DAMAGE TO THE MOTOR OR THE WINCH.

Winch Warm-Up Procedure

Performing a warm-up procedure is recommended at each start-up and is essential at ambient temperatures below 4° C (40° F).



FAILURE TO PROPERLY WARM UP THE WINCH, PARTICULARLY IN LOW TEMPERATURES, MAY RESULT IN TEMPORARY BRAKE SLIPPAGE. SUCH OPERATION WILL CREATE A HAZARDOUS SITUATION THAT MAY RESULT IN SERIOUS INJURY, DEATH AND/OR EQUIPMENT DAMAGE.

To properly warm up the winch, run the 10010's diesel engine at its minimum recommended RPM with the hydraulic winch control lever in its neutral position. Once the engine has reached operating temperature, operate the winch with no load at low speeds, forward and reverse, several times to prime all lines with warm hydraulic oil and to circulate gear lubricant through the planetary gear sets.

ANTI-TWO-BLOCK CONTROL

The winch functions employ an LMI/A2B operator aid to prevent a “two-block” situation.

When the load block or headache ball trips the anti-two-block switch, the switch actuates a solenoid valve which blocks control (pilot) pressure to the function.

AUGER OPERATION

If the 10010 is equipped with the optional auger package, the winch control lever also controls the direction and speed of the auger motor. The auger/winch selection is made by setting the dash-mounted **Auger/Vibro ON/OFF** toggle switch to the appropriate position.

This switch energizes solenoid valves that divert pilot pressure to the directional control valve for the selected function. The momentary push button at the top of the control lever also controls the speed of the auger, as it does with the winch. See *Winch Operation*.

6. BOOM CONTROLS

BOOM HOIST

The joystick control lever mounted in the far right position of the right hand console controls the **Boom UP/DOWN** function. This function consists of a manifold-mounted directional control valve which is connected to a single double-acting cylinder. The cylinder is fitted with an integral counterbalance valve that holds the cylinder in the extended position until pressure is applied to the retract port, unlocking the valve and allowing the cylinder to lower the boom.

To raise the boom, the control lever is pulled rearward; to lower the boom, the lever is pushed forward. As with all functions, the speed is directly proportional to engine speed and control displacement.

The hydraulic system is not designed to raise the extended boom from an angle of less than 40 degrees.

BOOM TELESCOPE

To the right of the swing brake pedal is the **Telescope OUT/IN** pedal. Pushing the pedal forward (toe down) extends the boom and pushing it backward (heel down) retracts the boom.

The boom telescope system consists of two cylinders* mounted inside the boom that supply the force to extend and retract the boom.

The boom is four-stage* and hydraulically operated. The second stage will extend fully before the third and fourth stages start to extend. As hydraulic pressure is applied to the sequence valve, the cylinder mounted in the second stage extends. At the end of its stroke, the valve will route the pressure to the cylinder mounted in the third stage. As the third stage extends, it will also extend the fourth (tip) stage through an arrangement of extend cables and sheaves mounted inside the boom. When retracting, the third and fourth stages will retract first, then the second stage will retract.

The boom telescope cylinders are equipped with integral counterbalance valves that hold the boom in the extended position until pressure is applied to the retract port, unlocking the counterbalance valve and allowing the cylinder(s) to retract. As with all other functions, retract speed is directly proportional to engine speed and control displacement.

* A two-stage, 40-foot boom with a single telescope cylinder is optional.

ANTI-TWO-BLOCK (A2B) CONTROL

The Boom Down and Boom Telescope Out functions employ the LMI/A2B operator aid to prevent a “two-block” situation.

When the load block or headache ball trips the anti-two-block switch, the switch actuates a solenoid valve which blocks control (pilot) pressure to the function.

7. SWING CONTROLS

SWING CONTROL

In the far left position of the left-hand console is the swing control. The swing system consists of a directional control valve, hydraulic motor, a spring-applied/hydraulically-released park brake with an integral spring-released hydraulically-applied service brake and a gear reducer mounted to the upper structure of the crane.

The console-mounted control lever supplies pilot pressure to the directional control valve which routes pump flow to the swing motor, which through the brake, causes the reducer to turn the shaft-mounted pinion gear, meshed with the slew ring, and the upper structure.

To swing left, the control lever is pulled rearward; to swing right, the lever is pushed forward. As with all functions of the crane, speed is directly proportional to engine speed and control displacement.

SWING PARK BRAKE

The park brake is controlled by the **Swing Park Brake ON/OFF** switch. The park brake is used to hold the upper structure in position for extended periods of time.



NEVER USE THE PARK BRAKE TO STOP THE SWING MOTION OF THE UPPER STRUCTURE UNDER ANY CIRCUMSTANCES

SWING SERVICE BRAKE

The service brake is controlled by the floor-mounted foot pedal (far left) and is used to slow and stop the swing motion of the crane upper structure.



NEVER REST YOUR FOOT ON THE SWING BRAKE PEDAL DURING SWING OPERATION; EVEN SLIGHT PRESSURE WILL CAUSE EXCESSIVE WEAR ON THE SWING BRAKE MECHANISM

At the top of the swing control lever is the horn button. When depressed, the horn will sound, alerting all personnel that swing or some other function is about to be put into motion. It is good practice to sound the horn before putting any functions into motion.

8. TRAVEL CONTROLS; TRACKS EXTEND/RETRACT CONTROLS

TRACKS FORWARD/REVERSE

The travel function is controlled by two floor-mounted foot pedals which actuate control valves to route pilot pressure to the manifold-mounted directional control valves. In the forward direction (boom over the idler end) the left pedal controls the left track and the right pedal controls the right track.

Pushing the pedal(s) toe-down moves the crane forward. For reverse travel, pushing the pedals heel-down moves the crane backward. The speed of travel, as with all other functions, is directly proportional to engine speed and control displacement.

To skid-steer, one of the pedals is pushed farther down than the other, causing one track to pull ahead of the other.

Counter-rotation (turning the crane on its own axis) is achieved by moving one pedal toe-down and the other heel-down, depending on the desired direction.

The track drive motors are equipped with spring-applied, pressure-released park brakes controlled by the dash-mounted **Park Brake ON/OFF** toggle switch. The park brake switch must be set to off before travel can be initiated. Also connected to the park brake switch is the motion alarm, which will sound any time the park brake switch is turned off. This alarm will alert all personnel that travel can occur at any time.

The track drive motors are two-speed and are shifted by pilot pressure through a solenoid valve controlled by a dash-mounted toggle switch, marked **Travel Speed HIGH/LOW**.



DO NOT SHIFT BETWEEN TRAVEL SPEEDS WHILE THE CRANE IS IN MOTION.

Maximum tractive effort is realized with the motors in "low" speed, the engine at top speed and maximum pedal displacement.

TRACKS EXTEND/RETRACT

The 10010's track extend/retract function powers the crawler frames in or out. The track extend/retract function is actuated by the dash-mounted **Tracks EXTEND/RETRACT** toggle switch. The carbody-mounted extend/retract cylinders are fitted with integral cross-flow check valves to prevent the cylinders from drifting in or out unless pressure is applied.



NEVER OPERATE THE CRANE WITHOUT FIRST FULLY EXTENDING THE CRAWLER FRAMES*.

ATTEMPTING TO LIFT LOADS WITH THE CRAWLER FRAMES RETRACTED WOULD VERY LIKELY CAUSE OVERTURNING, WHICH WILL RESULT IN SERIOUS INJURY, DEATH AND/OR EQUIPMENT DAMAGE*.

***UNLESS OPERATIONS ARE WITHIN PARAMETERS SPECIFICALLY ALLOWED BY THE "TRACKS RETRACTED LOAD CHART" FOR THIS MODEL.**

9. AUXILIARY WINCH CONTROL

AUXILIARY WINCH (OPTIONAL)

If the crane is equipped with the optional two-speed auxiliary winch, winch operation is controlled by the

Auxiliary Winch

control
lever on
the right-
side opera-



tor's console. Side-to-side movement of the four-way joystick controls the auxiliary winch. Moving it rightward lowers the hook block and moving it leftward raises the hook block.

The dash-mounted **Winch Speed** toggle switch selects the high or low range of auxiliary winch rotation speed. As with other crane functions, speed within ranges is directly proportional to engine speed and control displacement.

The auxiliary winch also employs an LMI/A2B operator aid, in the “raise” direction, to aid the operator in preventing a two blocking situation when the switch-mounted weight at the boom, stand off, extension or jib tip is raised by the hook block or headache ball.

NEVER LEAVE THE CRANE CAB WITH THE ENGINE RUNNING.

10. TOOL/AUGER OPERATION

The MANTIS 10010 may be equipped with the optional tool circuit for operating hydraulic impact wrenches, tampers, etc. The tool circuit is designed to deliver either 5 or 10 GPM at 2100 PSI (18.9 or 37.8 l/min @ 147 bar), to the reel-mounted hose at the left side of the crane, behind the operator's cab. Hoses on the reel are fitted with quick-disconnect couplings to attach the desired tool. The tool circuit is activated by the dash-mounted **Tool HIGH/OFF/LOW** toggle switch.

Digging With the Auger

NOTE:

All auger controls described below are located in the right-hand operator's console.

The optional auger circuit utilizes the winch control lever to control the direction and speed of auger rotation. The operator selects auger operation by setting the **Auger/ Winch** toggle switch to the AUGER position.

Use the following steps to prepare the auger for digging:

1. Set the **Auger/Winch** switch to the AUGER position and remove the safety pin from the auger storage latch.
2. Slowly push the **Winch/Auger Control** lever forward to be sure the wind-up cable is supporting the auger.
3. Open the latch by setting the **Auger Latch OPEN/CLOSE** toggle switch to the OPEN position.
4. With the latch open, slowly pull the control lever rearward to lower the auger out of the latch until the wind-up cable swings clear.

With the auger in digging position, push the winch control lever forward to dig and pull it rearward for reverse. As with all other functions, auger rotation speed is directly proportional to engine speed and control lever displacement.

APPENDIX A: BOOM LOAD CHARTS

CAPACITY LIMITS AND GENERAL CONDITIONS

The MANTIS 10010 Crane as manufactured by SpanDeck, Inc. meets the requirements of ANSI B30.5c (1992) when specifically equipped. Structure and stability have been tested in accordance with SAE J1063 and SAE J765, respectively. Lifting capacities as determined by boom length, angle, or lifting radius apply only to machines as originally equipped by the manufacturer and in a properly maintained condition.

Capacities given are maximum covered by the manufacturer's warranty and are based on a freely suspended load with no allowance for factors such as out-of-level operation, supporting surface conditions, hazardous surroundings, experience of personnel, etc.

The operator shall establish practical working loads based on prevailing operating conditions such as, but not limited to, those listed above.

When making lifts where capacities may be within a zone limited by structural strength, the operator shall determine that the weight of the load is known within $\pm 10\%$ before making the lift.

DO NOT lift a load without consulting the Load Chart. Deductions from rated capacities must be made for the weight of the hook block, overhaul ball, slings, spreader bar, or other suspended equipment.



SIDE PULL ON THE BOOM IS EXTREMELY DANGEROUS AND MUST BE AVOIDED.

DO NOT EXCEED THE MANUFACTURER'S SPECIFIED MAXIMUM REEVING.

Load radius is defined as the horizontal distance from the axis of rotation to the center of the lifting device after load is applied.

Boom angle is the included angle between the longitudinal axis of the boom base section and the horizontal axis, after lifting the load. The boom angle before lifting should be somewhat greater than desired to account for boom deflection.

Boom angle/boom length relationships given in the load charts are an approximation of the resulting load radius. The radius should be accurately measured.

Boom height dimensions are measured from ground to center of lower boom head sheave.

It is permissible to attempt to telescope the boom with a load within the limits of rated capacities. However, boom angle, system hydraulic pressure, and/or boom lubrication may affect operation.



THE LOAD MOMENT INDICATOR SYSTEM USED ON THE 10010 IS AN OPERATIONAL AID THAT WARNS THE CRANE OPERATOR OF APPROACHING OVERLOAD CONDITIONS AND ALSO WARNS OF OVERHOIST CONDITIONS WHICH COULD CAUSE DAMAGE TO EQUIPMENT AND INJURY TO PERSONNEL.

THE DEVICE IS NOT, AND SHALL NOT BE, A SUBSTITUTE FOR GOOD OPERATOR JUDGMENT, EXPERIENCE, AND THE USE OF ACCEPTED CRANE OPERATING PROCEDURES.

THE RESPONSIBILITY FOR THE SAFE OPERATION OF THE CRANE SHALL REMAIN WITH THE CRANE OPERATOR, WHO SHALL ENSURE THAT HE UNDERSTANDS AND OBSERVES ALL SUPPLIED WARNINGS AND INSTRUCTIONS.

PRIOR TO OPERATING THE CRANE, THE OPERATOR MUST CAREFULLY AND THOROUGHLY READ AND UNDERSTAND THE INFORMATION IN THIS MANUAL TO ENSURE THAT HE KNOWS THE OPERATION AND LIMITATIONS OF THE LMI/A2B SYSTEM AND CRANE.

PROPER FUNCTIONING IS DEPENDENT UPON PROPER DAILY INSPECTIONS AND UPON OBSERVATION OF THE OPERATING INSTRUCTIONS SET FORTH IN THE LMI/A2B MANUAL.

APPENDIX B: MAINTENANCE CHART

								COMMENTS
ENGINE								
Crankcase								
Check oil level	●							check at dipstick
Check for leaks	●							repair, see Capacities & Specifications Chart
Change oil and filter				●				see Manufacturer Maintenance manual
Check valve lash				●				
Clean crankcase breather				●				
Cooling System								
Check coolant level	●							check "cold", add as required
Check for leaks	●							see Capacities & Specifications Chart
Fuel System								
Check fuel level	●							fill at end of each day
Drain fuel/water separator	●							
Drain dirty fuel		●						drain until clean fuel evident
Replace fuel filter				●				see Manufacturer Maintenance manual
Drain water/sediment from tank				●				
Clean fuel inlet & screen				●				
Air Supply								
Clean air pre-cleaner bleeder valve	●							
HYDRAULIC SYSTEM								
Check hydraulic oil level	●							check for "Desired Level" at tank sight gauge, all cylinders fully retracted and oil at operating temperature. Add as required, see Capacities & Specifications Chart
Check filter condition indicator	●					●		change as required, or at least every 1,000 hrs.
Check for leaks	●							"walk around" inspection of entire machine, repair as required
Clean hydraulic tank filler/breather cap					●			clean with solvent
Drain hydraulic tank						●		drain, clean, and refill, see Capacities & Specifications Chart
Change hydraulic filters								
new or rebuilt machines			●					
after 1st filter change						●		after initial filter change at 100 hours
TRAVEL/TRACKS								
Check track drive reducers		●						check level at "level" plug with "fill" and "drain" plugs in vertical alignment. Add as required, see Capacities & Specifications Chart

[REDACTED]						COMMENTS
TRAVEL/TRACKS (continued)						
Check/Adjust track tension		●				measure slack between top rollers; 30mm / 1.187 inches.
Clean/Grease track extend beams		●				remove all debris and coat top, side, and bottom surfaces
Inspect undercarriage					●	check all components for wear/damage, repair or replace as required.
WINCH(ES)						
Check oil level		●				add as required
Check for leaks		●				repair as required
Change oil (1st time)			●			see Capacities & Specifications Chart
Change oil (after 1st change)					●	see Capacities & Specifications Chart
BOOM						
Grease boom sheave		●				inspect for damage, replace as required, see Capacities & Specifications Chart
Grease boom bearing pads		●				inspect for damage, replace as required, see Capacities & Specifications Chart
Grease boom pins		●				inspect for damage, replace as required, see Capacities & Specifications Chart
Change swing drive reducer oil		●				drain at operating temperature (initial oil change) see Capacities & Specifications Chart
Change swing drive reducer oil					●	after initial change at 50 hours
Grease slew ring race		●				grease while rotating until grease is visible at seal, see Capacities & Specifications Chart
Grease slew ring teeth		●				coat with open gear lube
Check wire rope		●				check for damage, replace as required
AUXILIARY GENERATOR (OPTION)						
Check oil level	●					
Change oil		●				initial oil change
Replace air cleaner element		●				
Change fuel filter			●			
Clean fins			●			clean cooling air flow path
Change oil and filter				●		after initial oil change
CAB INSTRUMENTATION						
Check for proper operation	●					repair or replace as required

APPENDIX C: CAPACITIES & SPECIFICATIONS

EQUIPMENT	MATERIAL	CAPACITY/QUANTITY	COMMENTS
Engine Lube Oil	API CF-4/SG CF-4/SF CE/SG SAE 15w40	15 l (16 US quarts) 23.8 l (25.2 US quarts)	Cat 3116, Cummins B5.9 Cummins C8.3 capacities with filter change
Engine Cooling System	water/antifreeze mix	24.2 l (26.7 US quarts) 18.9 liters (20 US quarts) 26.5 l (28 US quarts)	Cat 3116 Cummins B5.9 Cummins C8.3 use mix for protection at ambient temperatures
Hydraulic Tank	Shell Tellus T-32	1200 liters (350 US gallons) 1000 liters (264 US gallons)	8010/10010/12010 6610
Diesel Fuel Tank	No.1 or No.2 Diesel	420 liters (110 US gallons) 302 liters (80 US gallons)	8010/10010/12010 6610
Swing Drive Reducer	EP 90	fill to 4.5 cm (1.75 inches) below outside of housing fill/check plug, minimum	
Winch (Main & Aux.)	Texaco Meropa 150 (-20°F to 80°F) Mobil SHC 630 synthetic (-40°F to -20°F)	fill to bottom of level plug CH175: 4.3 l (4.5 US qts) CH185: 17.0 l (18 US qts) PD12C: 1.4 l (1.5 US qts)	8010 main, aux: CH175 100/12010 main: CH185 100/12010 aux: CH175 6610 main: CH175 6610 aux: PD12C
Track Drive Reducers	EP 90	6 liters (6.4 US quarts) 6.8 liters (7.5 US quarts)	100/12010 (Linde) 6610/8010 (KYB-5000)
Track Rollers	EP 90	0.34kg (.75 US lbs.) 0.23 l (.24 US quart)	Berco KL18C InterTractor see * below for filling
Track Idlers	EP 90	0.45 kg (.99 US lbs.)	
Boom Sheaves	Shell Alvania EP-2 or Equis	until "new" grease is visible	Fittings in end of pins (12 places)
Boom Cylinder Pins	EP-2	until "new" grease is visible	4 places
Boom Foot Pin	EP-2	until "new" grease is visible	2 places
Boom Bearing Pads	EP-2	as required	spread grease on bearing areas of boom
Slew Ring Race	Shell Alvania EP-2 or equivalent	as required	grease while rotating until "new" grease is visible at seal
Slew Ring Teeth	Texaco "Crater" 2X or 5X	coat teeth at each greasing	
Batteries	Distilled water	keep level at split rings under caps	
Auger Motor	GL-5 EP SAE 80/90	4.7 liters (5 US quarts)	Eskridge Model 74 see ** below for filling
Auxiliary Generator • Lube oil • Fuel tank	(Optional) same as main engine see Diesel Fuel Tank	0.8 liters	connected to tank of crane
Track tension	Shell Alvania EP-2 or equivalent	as required	see maintenance chart for adjustment procedure

* Test level with fill plug removed; maximum level: no overflow from fill hole @ 40° above horizontal axis;
minimum level: overflow from fill hole @ 10° above horizontal axis.

** Measure to middle of primary planet gears when the auger is in vertical position. Tilt back slightly when
filling through oil fill hole to achieve proper capacity.

APPENDIX D: FILTER SPECIFICATIONS

FILTER SPECIFICATIONS				
	6610 (CATERPILLAR 3116)	8010/10010/12010 (CATERPILLAR 3116)	6610 (CUMMINS 6B-5.9)	8010/10010/12010 (CUMMINS 6C-8.3)
Lubricating Oil	IR 0739	IR 0739	LF 3349	LF 3000
Fuel	IR 0740	IR 0740	-----	-----
Fuel/Water Separator (Donaldson)	P92 0711	P92 0711	P92 0711	P92 0711
Engine Air (Farr)	T-519	P 40	P 40	P 40
Cooling System (Precharge)* (Service)	----- -----	----- -----	----- -----	WF 2073 WF 2071
Hydraulic Return (Donaldson)	P16 4703	P16 4703	P16 4703	P16 4703
Hydraulic Pilot Oil (Fairey-Arlon)	170 Z 110A	170 Z 110A	170 Z 110A	170 Z 110A
* Contains additives to protect coolant system from corrosion; use this filter only at complete coolant change.				

APPENDIX E: COLD WEATHER OPERATION

Diesel engines can operate effectively in cold weather. Engine operation in cold weather, however, is dependent on the type of fuel used and how well the fuel moves through the fuel-related components. The purpose of this appendix is to explain some of the problems and steps that can be taken to minimize fuel problems during cold weather operation when the engine area is colder than 40° F (5° C).

Fuel Selection

During cold weather operation, you may need to use No. 2 diesel fuel since quantities of No. 1 diesel fuel are limited and generally are only available during the winter months and in the colder climates.

There are two major differences between No. 1 and No. 2 diesel. No. 1 diesel has a lower cloud point and a lower pour point.

The cloud point is the temperature at which a cloud or haze of wax crystals begins to form in the fuel and cause fuel filters to plug. The pour point is the temperature at which diesel fuel begins to thicken and becomes more resistant to flow through fuel pumps and lines.

Be aware of these fuel values when purchasing your diesel fuel and anticipate the average outside (ambient) temperature for the area where your Mantis crane will be operating. Engines fueled in one climate may not operate satisfactorily if moved to another because of problems that result from cold weather.

NOTE:

The average No. 1 diesel fuel has a lower heat content (kJ or BTU) rating per unit volume of fuel than the average No. 2 diesel fuel. When using No. 1 diesel fuel, you may notice a drop in power and fuel efficiency, but you should not experience any other operating effects.

Before troubleshooting for low power or poor performance in winter months, check the type of fuel you are using.

The use of starting aids, engine oil pan heaters, coolant heaters, fuel heaters, and fuel line insulation also provide some means of minimizing starting and fuel problems in cold weather when No. 2 fuel is used.

Fuel Heaters

Fuel heaters prevent plugging of the fuel filters due to waxing in cold weather. Mantis cranes intended for use in cold climates are equipped with suitable fuel heaters and control circuitry. See the Maintenance Manual for your crane for details.

Make sure that the fuel heater is deactivated in warm weather. A loss of engine power can occur if the fuel supply temperature exceeds 85° F (30° C).

Fuel Filters

Mantis diesel-powered cranes are equipped with a water separator between the fuel tank and the engine-mounted fuel filter. The micron rating and location of the water separator are chosen for proper operation in cold weather. The water separator and its fuel supply line are the components most commonly affected by cold fuel.

Engine Compartment Temperature

Maintaining as high a temperature as possible in the engine compartment can be very helpful in avoiding cold weather problems in your Mantis crane.

Always keep all engine covers and access panels closed in cold weather to retain as much engine heat as possible.

Depending on the options you specified, your crane may have a radiator shutter, winter front, and/or thermostatically controlled (clutch-type) fan to minimize warm-up times.

At coolant temperatures below 160° F (71° C) the clutch fan should be off; at temperatures above 205° F (96° C) the fan should operate. If your engine will not maintain proper operating temperature, check the fan for proper operation.

APPENDIX F: REEVING DIAGRAM

Lower the auger into the earth by pushing the **Boom UP/DOWN** lever forward; raise the auger by pulling the

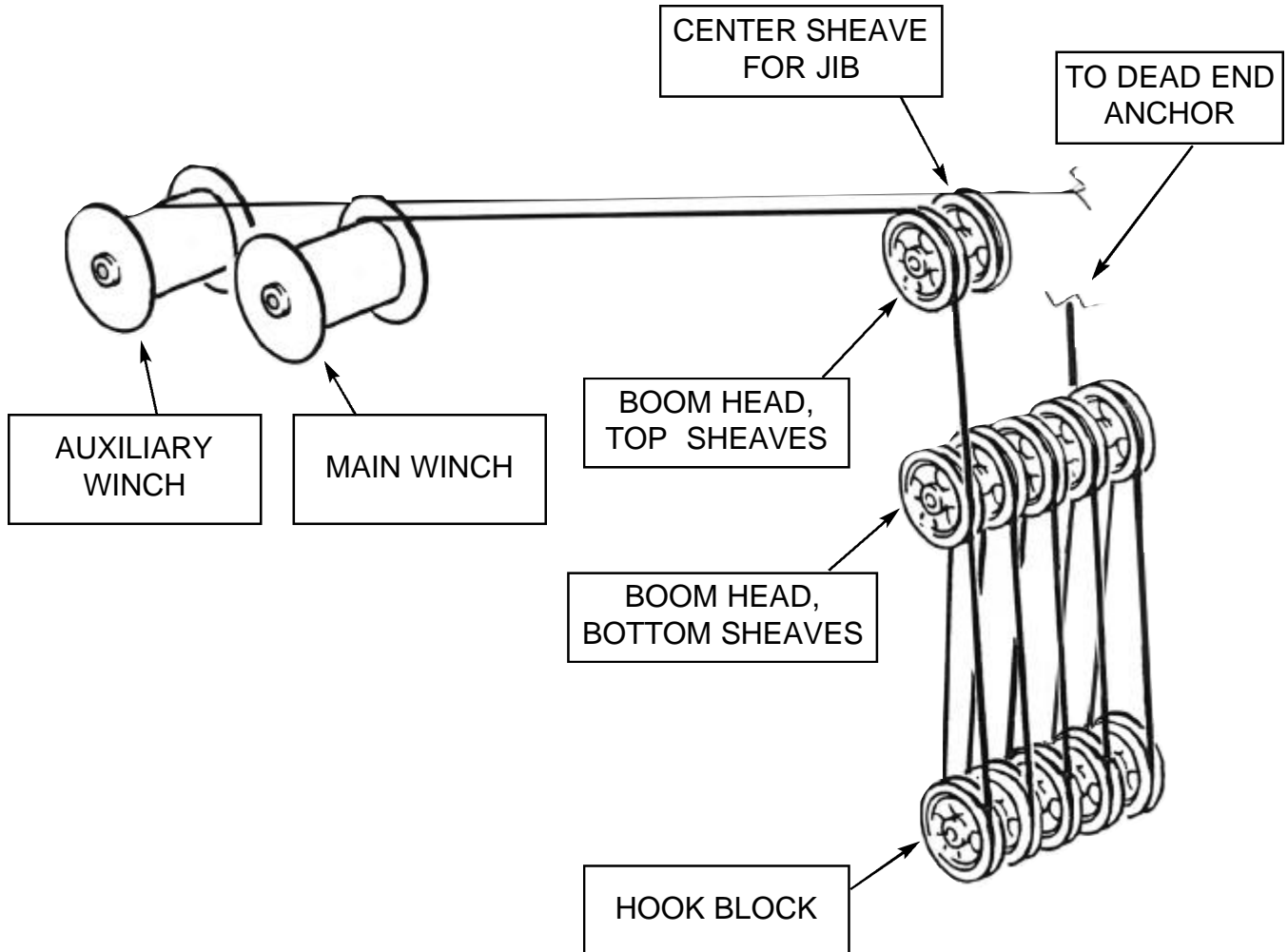

lever backward. The operator must determine proper digging and lowering rates depending on soil conditions.

High or low range of auger rotation speed is selected with the **Auger Speed HIGH/LOW** Switch.



DO NOT EXCEED THE MANUFACTURER'S
SPECIFIED MAXIMUM REEVING OF
10 PARTS OF LINE

Stowing the Auger

When digging is complete, return the auger to the stowed position in the storage latch using the following steps:

1. Attach the wind-up cable to the auger shaft. Move the **Auger Latch OPEN/CLOSE** switch to OPEN.
2. Push the **Winch/Auger Control** lever forward to draw the auger into the latch.
3. After the auger shaft contacts the torque limiting valve and the motor stops rotating, set the **Auger Latch OPEN/CLOSE** switch to CLOSE, install the safety pin, and pull the control lever rearward, lowering the auger shaft to the latch plunger.

When not in use, the auger may be left in the digging position with the **Auger/Winch** switch set to WINCH, if desired, to prevent spending excessive time in storing and rigging the auger.

NOTE:
10-PART REEVING IS REQUIRED FOR FULL
CAPACITY LIFTING

APPENDIX G: PREPARATION FOR SHIPPING



Removable Component Weights & Dimensions

Weights are given in KIPs (pounds)

	6610	8010	10010/12010
Crawler frame	17.6 (17,600)	17.6 (17,600)	17.6 (17,600)
Counterweight(s)	10.0 (10,000)	15.0 (15,000)*	30.0 (30,000) [2 @ 15.0]
Lattice jib	0.7 (700)	0.7 (700)	0.7 (700)
Lattice extension	1.1 (1,100)	1.1 (1,100)	1.1 (1,100)
Main boom	13.7 (13,700)	19.7 (19,700)	19.7 (19,700)
Boom hoist cylinder	1.6 (1,600)	1.6 (1,600)	3.0 (3,000)
Foot pin centerline to boom CG (center of gravity)	5.9m (19.4ft)	5.4m (17.8ft)	5.4m (17.8ft)

*Heavy lift option adds 2nd 15.0 KIP (15,000 lb) counterweight

Due to the weight and overall width of the Mantis 6610/8010 and 10010/12010 cranes, it may be necessary to remove certain components from the machine for transport in your area. The procedures in the following appendices will guide you through disassembly and reassembly of your crane if the need arises.

WHEN INSTALLING OR REMOVING ANY COMPONENT OF A MANTIS CRANE, USE THE SAME SAFETY PROCEDURES THAT YOU USE WHEN MAKING ANY OTHER LIFT WITH THE CRANE.

NOTE:

The disassembly and reassembly of crane components will be much easier if performed on a smooth, stable, level surface.

The easily-removed components are:

- counterweight(s);
- lattice jib and extension;
- main boom; and
- crawler frames intact.

Disassembly or reassembly of any of these parts of the crane will require a crane or other lifting machine of rated capacity to handle the components to be removed.

APPENDIX H:

COUNTERWEIGHT REMOVAL/INSTALLATION

The counterweight of the 10010 is installed or removed by using the crane's Boom Telescope Out/In Control (see Page 9) with special counterweight handling rigging installed.



WHEN INSTALLING OR REMOVING THE COUNTERWEIGHT, USE THE SAME SAFETY PROCEDURES THAT YOU USE WHEN MAKING ANY OTHER LIFT WITH THE 10010.

NOTE:

Installing or removing the counterweight is much easier if the crane is on a level surface. If you can not level the crane completely, select a location that levels it from side to side.

Installing the Counterweight

1. Set the counterweight on level ground behind the crane, directly below its installed position.
2. Install the counterweight handling sheave in the sheave bracket slot. The rear edge of the sheave should be directly above the counterweight lifting lug.
3. Lower the boom fully and attach one end of the counterweight handling pendant to the upper boomhead lug. Run the pendant cable over the sheave installed in Step 2 and attach the free end to the counterweight lifting lug.
4. Raise the boom far enough so that the pendant cable clears both the main and auxiliary winches.
5. Using the Boom Telescope Control, extend the boom until the counterweight support lugs align with the mounting lugs on the 10010.

6. Install the counterweight support pins; release the tension on the pendant cable by retracting the boom.
7. Lower the boom fully; detach the counterweight handling pendant from the counterweight and boomhead lugs.
8. Install the two bolts that secure the lower edge of the counterweight to the crane body.

Removing the Counterweight

1. Remove the two bolts that secure the lower edge of the counterweight to the crane body.
2. Install the counterweight handling sheave in the sheave bracket slot. The rear edge of the sheave should be directly above the counterweight lifting lug.
3. Lower the boom fully and attach one end of the counterweight handling pendant to the upper boomhead lug. Run the pendant cable over the sheave installed in Step 2 and attach the free end to the counterweight lifting lug.
4. Raise the boom far enough so that the pendant cable clears both the main and auxiliary winches.
5. Using the Boom Telescope Control, extend the boom until the pendant cable is taut and supports the counterweight. The counterweight support pins should now be bearing no weight.
6. Remove the counterweight support pins; lower the counterweight to the ground by retracting the boom.
7. Lower the boom fully; detach the counterweight handling pendant from the counterweight and boomhead lugs.

APPENDIX I: JIB/EXTENSION REMOVAL/INSTALLATION



LIFTING POINTS FOR JIB ALONE, EXTENSION ALONE,
AND JIB & EXTENSION TOGETHER

Center lifting slings around the points indicated
DRAWING NOT TO SCALE

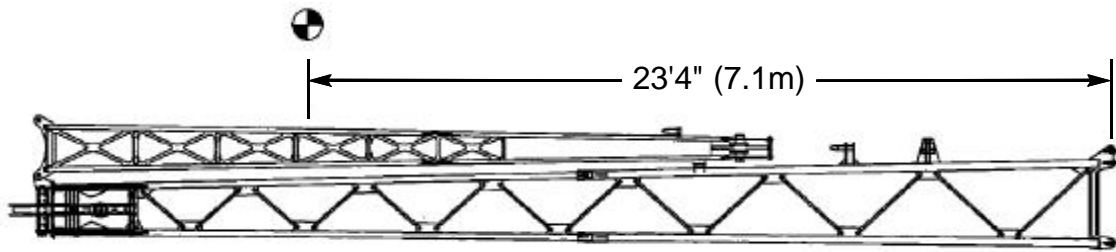

JIB & EXTENSION TOGETHER

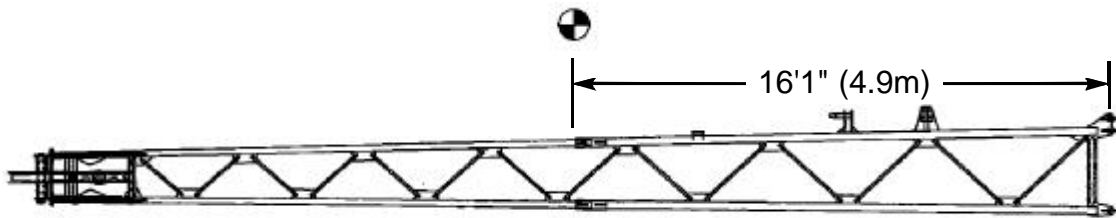

EXTENSION

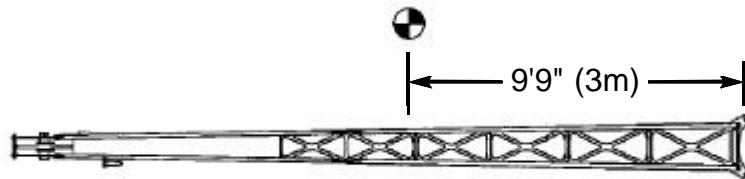

JIB

APPENDIX J:

MAIN BOOM REMOVAL/INSTALLATION



WHEN INSTALLING OR REMOVING THE JIB/EXTENSION, USE THE SAME SAFETY PROCEDURES THAT YOU USE WHEN MAKING ANY OTHER LIFT WITH THE CRANE.

4. Remove the pin from the jib storage bracket at the rear of the boom; remove the wing nut at the jib tip sheave location storage bracket; and remove the pins at the extension attachment to the main boom head.
5. Using the tag lines to maneuver the load, slowly lift the jib/extension off the support brackets and move it away from the main boom. Lower the jib/extension to the ground, clear of the work area, and set it on supporting blocking.



TO PRE-DAMAGE TO THE JIB/EXTENSION WHEN REMOVING IT FROM THE MAIN BOOM, ALWAYS USE NYLON SLINGS OF RATED CAPACITY TO HANDLE THE LOAD.



SLING ONLY AROUND THE MAIN CHORDS OF THE JIB AND/OR EXTENSION. APPLYING THE SLING TO LATTICE WORK WILL DAMAGE THE JIB OR EXTENSION.

DO NOT SET THE JIB/EXTENSION DIRECTLY ON THE GROUND; DAMAGE TO LATTICE WORK MAY OCCUR.

6. Store all attachment hardware in the crane storage box located under the hydraulic tank.

See the figures on the next page for placement of slings to attain the best balance of components. It is advisable to have the jib and extension in the stowed position and remove both as a unit, since both components are supported by the storage brackets on the main boom.

Removing the Jib and Extension

To remove the jib and extension as a unit, follow the steps outlined below.

1. Lower the main boom to a level position.
2. Attach slings at the locations shown in the figure. Attach tag lines to each end of the load.
3. "Snug up" on the slings to be sure the load is secure. Do not lift the load at this time. Check to be sure all rigging is secure.

Installing the Jib and Extension

To install the jib and extension as a unit, follow the steps outlined below.

1. Lower the main boom to a level position.
2. Attach slings to the jib/extension at the locations shown in the figure. Attach tag lines to both ends of the load.
3. Using the tag lines to maneuver the load, slowly lift the jib/extension off the supporting blocking and move it toward the main boom.
4. Align the attachment lugs on the extension with the corresponding lugs on the boom head. Install the pins through the attachment lugs and secure them.
5. Install and tighten the wing nut at the jib tip sheave location storage bracket.
6. Release tension on the lifting slings and disconnect them from the extension.

WHEN INSTALLING OR REMOVING THE MAIN BOOM, USE THE SAME SAFETY PROCEDURES THAT YOU USE WHEN MAKING ANY OTHER LIFT WITH THE CRANE.

PARTS OF THIS PROCEDURE REQUIRE USE OF THE CRANE'S POWER. NEVER ACTIVATE ANY OF THE CRANE CONTROLS WHILE PERSONNEL ARE IN CONTACT WITH ANY PART OF THE BOOM.

BE SURE ALL RIGGING AND LIFTING EQUIPMENT IS OF ADEQUATE CAPACITY TO HANDLE THE BOOM OR CYLINDER SAFELY. SEE THE COMPONENT WEIGHT & DIMENSIONS CHART, APPENDIX G, FOR SPECIFICS.

Removing the Main Boom

To remove the main boom, you must support both the boom and boom hoist cylinder while removing the cylinder rod end pin. DO NOT drive the pin out and allow the boom hoist cylinder to "drop."

1. Start the crane's engine. Using the Boom Telescope Out/In control, retract the boom fully.
2. Using the Boom Hoist Raise/Lower control, lower the boom until the boom head is supported on wood blocking on the transport truck/trailer. Block up at a position which maintains 6" (150mm) of extension of the boom hoist cylinder. Remove the hook block(s); roll all wire rope onto the winch drum(s) and secure.
3. Attach a nylon sling to the boom hoist cylinder in a "half hitch" to prevent slippage, and connect to rigging "straddling" the boom. Snug up on the load.

4. Remove the boom hoist cylinder pin retainer bolts and plates at both the rod end and butt end; stow these parts, as well as all other parts removed during this procedure, in the crane storage box located under the hydraulic tank.
5. Check for loading on the rod end pin by striking the end of the pin with a hammer. Increase or decrease tension on the nylon sling to minimize loading. Drive the pin out.

ALWAYS WEAR EYE PROTECTION WHEN STRIKING ANY OBJECT WITH A HAMMER.

6. With the boom hoist cylinder rod end pin removed, lower the cylinder until it rests on the upper structure base plate.
7. Remove the operator aid male plug from its receptacle at the rear left of the boom butt stage. Disconnect the boom extend cylinder and boom hoist cylinder hydraulic lines at the cylinder end. Cap or plug all disconnected fittings. Secure the hydraulic lines to the upper structure to protect them from damage.
8. Locate the center of gravity (see Appendix G) of the main boom assembly. Using chokers around the boom, attach the boom to a crane or other lifting machine.
9. Remove the boom foot pin bolts and retainer located on the engine (right) end of the foot pin. Attach a tag line at the boom head.

APPENDIX K: CRAWLER FRAME REMOVAL/INSTALLATION

10. Raise the boom slightly to remove the blocking supporting the boom head,



then lower it to a level position.

11. Check loading on the boom foot pin by striking the pin with a hammer. If necessary, relieve loading at the pin by raising or lowering the boom slightly.
12. Remove the boom foot pin by driving it out with a hammer and wood block or by using a slide hammer (pin is tapped 1"-8 UNC).
13. Move the boom to a waiting truck or storage area and support it with appropriate blocking.
14. Support the boom hoist cylinder with a sling near its center. Remove the cylinder butt end pin by driving it out with a hammer and wood block.

Installing the Main Boom

1. Move the crane, boom hoist cylinder, and boom within range of the lifting device to be used.
2. Attach a sling around the boom hoist cylinder near its center of gravity; use a "half hitch" to prevent slippage. Raise the cylinder into position and install the cylinder butt end pin by driving it in with a hammer and wood block; bolt the pin retainer into position. Lower the cylinder slowly until there is no tension on the lifting device, and remove the sling.
3. Locate the center of gravity (Appendix G) of the main boom assembly. Using chokers around the boom, attach the boom to the lifting machine. Attach a tag line to the boom head.

4. Lift the boom into position and install the boom foot pin; bolt the foot pin retainer into position.
5. Support the boom head with wood blocking. Release tension on the lifting device and remove the chokers.
6. Remove the caps and plugs from the boom extend cylinder and boom hoist cylinder hydraulic line fittings and attach the lines to their respective ports.
7. Attach a nylon sling to the boom hoist cylinder in a "half hitch" and connect it to rigging "straddling" the boom. Raise the cylinder into position.
8. Start the crane's engine. Using the crane's hydraulic power, extend the boom hoist cylinder slowly with the Boom Up/Down control lever until the cylinder rod end aligns with its attachment point on the boom.
9. Install the rod end pin; bolt the pin retainer into position. Release tension on the sling around the boom hoist cylinder and remove the sling.
10. Again using crane hydraulic power, raise the boom fully while checking to make sure that the hydraulic lines are not pinched or binding.
11. Install and rig the hook block(s).

WHEN INSTALLING OR REMOVING THE CRAWLER FRAMES, USE THE SAME SAFETY PROCEDURES THAT YOU USE WHEN MAKING ANY OTHER LIFT WITH THE CRANE.

PARTS OF THIS PROCEDURE REQUIRE USE OF THE CRANE'S POWER. NEVER ACTIVATE ANY OF THE CRANE CONTROLS WHILE PERSONNEL ARE IN CONTACT WITH ANY PART OF THE CRAWLER FRAMES.

Removing the Crawler Frames

The Mantis 6610/8010 and 10010/12010 crawler frames are held in place by wedges at the four extend beam locations. The frames are removed by removing the wedges while the crane is supported on a trailer.

1. With tracks fully extended, drive the crane over a "lowered" detachable goose neck or beam trailer, and position it for best load distribution.
2. Block between trailer/beams and the bottom of the crane carbody using hardwood blocks.
3. Using trailer/truck power, raise the trailer to support the crane's weight at a level position, with the crane's tracks just contacting the ground.
4. Remove both wedge retaining bolts at each wedge. Loosen the crawler frame/track extend cylinder flange retaining bolts and back them out approximately 1/2" (12mm).
5. Start the crane. Using the Tracks EXTEND/RETRACT toggle switch, retract and extend the crawler frames slightly in a "rocking" motion to release the wedges. If the crawler frames do not loosen, lower the trailer slightly to increase friction between the tracks and the ground and repeat the "rocking" motion. Once all four wedges have loosened, remove all wedge retaining bolts and wedges.
6. Remove the four bolts that attach the track extend cylinder/crawler frame connecting flange at each extend cylinder rod location, and retract the extend beams fully into the carbody. Install the wedges removed in Step 5 on the extend beams and tighten the bolts for storage. Install the extend cylinder/crawler frame connecting flange bolts in the crawler frames and tighten for storage.
7. Install the lifting eyes or bars provided. With appropriate rigging and lifting machinery; load the crawler frames onto another truck or trailer or move them to a storage area.

Installing the Crawler Frames

1. Remove the wedges stored on the extend beams. Remove the extend cylinder/crawler frame connecting flange bolts from the crawler frames.
2. Install the lifting eyes or bars provided. With appropriate rigging and lifting machinery; lift the crawler frames from the truck or trailer and move them into position beside the crane.
3. Start the crane. Using the Tracks EXTEND/RETRACT toggle switch, extend the extend beams until the connecting flanges contact the crawler frames. If necessary, use trailer/truck power to align the extend beams and crawler frames.
4. Install the wedges removed in Step 1 on the extend beams and tighten the bolts as far as possible. Install but do not tighten the extend cylinder/crawler frame connecting flange bolts in the crawler frames.
5. With the crawler frames mounted to the extend beams, crawler frame/extend cylinder flange bolts installed and backed out approximately 1/4" (6mm), and wedges and wedge retainer bolts tightened, lower the trailer to allow the crawler frames to support the weight of the crane.

APPENDIX L: EXTENSION/JIB ERECTION & RIGGING

6. Extend and retract the tracks in a “rocking” motion, stopping on the retract stroke to retighten the wedge retaining bolts. Repeat this step until all wedge retaining bolts are tightened to 900 ft-lb.

7. Tighten the crawler frame/extend cylinder flange retaining bolts to a torque of 375 ft-lb. Recheck the wedge retaining bolt torque at 10-hour intervals for the first 50 hours of operation after installation and at 50-hour intervals thereafter. Do not operate the crane if the wedge retaining bolts are not tightened to the proper torque.



The 6610/8010 and 10010/12010 cranes may be equipped with the optional 30-foot lattice extension and 20-foot lattice jib.

The extension may be used alone or with the jib. The jib is used only with the extension.

When the extension is used alone, it is rigged either 1-part with an overhaul ball or 2-part with a hook block. When the extension and jib are used together, rigging is 1-part with an overhaul ball.

The extension and jib are stowed alongside the main boom when not in use.

Follow the steps below to erect the extension alone from its stowed position. See the figures on the following pages for location of the details mentioned in this procedure.

1. Retract the boom fully and lower it to a horizontal position.
2. The two far right pin bosses on the boom head should be aligned with the pin bosses on the extension. Insert two pins "A" into the two aligned holes of the boom head and extension and install retainers on them.

PARTS OF THIS PROCEDURE REQUIRE USE OF THE CRANE'S POWER. NEVER ACTIVATE ANY OF THE CRANE CONTROLS WHILE PERSONNEL ARE IN CONTACT WITH ANY PART OF THE BOOM, EXTENSION, OR JIB.

NOTE:

Erecting or stowing the jib & extension is much easier if the crane is on a level surface.

All left and right directional references are as viewed

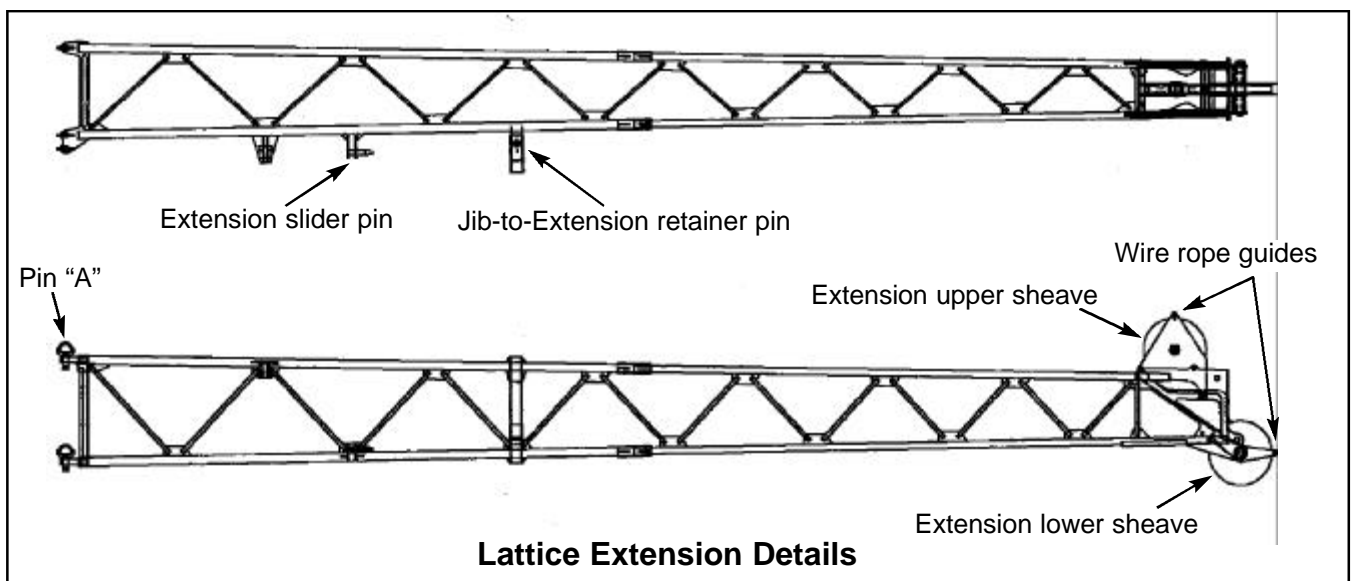

from the crane operator's seat

Erecting and Rigging the Extension

3. Remove the two pins "B" which connect the jib to the jib transition bracket in the stowed position. Remove the retainers from the extension slider pins and release the jib-to-extension retainer pin. Extend the boom slowly until the extension slider pins clear their mating pockets and the extension hook clears the extension alignment ramp.
4. Use the tag line to swing the extension into alignment with the main boom. The four remaining pin bosses on the boom head should now be aligned with the pin bosses on the extension. Insert four additional pins "A" into the four aligned pairs of bosses on the boom head and extension. Install retainers on all pins "A".
5. Rigging with the extension only does not require the jib transition bracket. Remove the two pins "C" securing the jib transition bracket to the extension tip and remove the bracket. The pins are retained by through-bolts near the handle end of the pins.
6. Install the extension lower sheave. Route the wire rope from the auxiliary winch drum over the top wire rope guide in the boom head and over the extension upper and lower sheaves. Install the lower sheave wire rope guide assembly and pin.
7. For 1-part rigging, install the wedge and socket (becket) and overhaul ball.
8. For 2-part rigging, route the wire rope end around the hook block sheave. Install the becket and attach it to the dead end anchor point on the extension tip.
9. Install the A2B jumper cable between the boom head and extension. Plug the male connectors into the female receptacles. Install the A2B switch at the pivot location on the extension lower sheave and plug it into its receptacle.

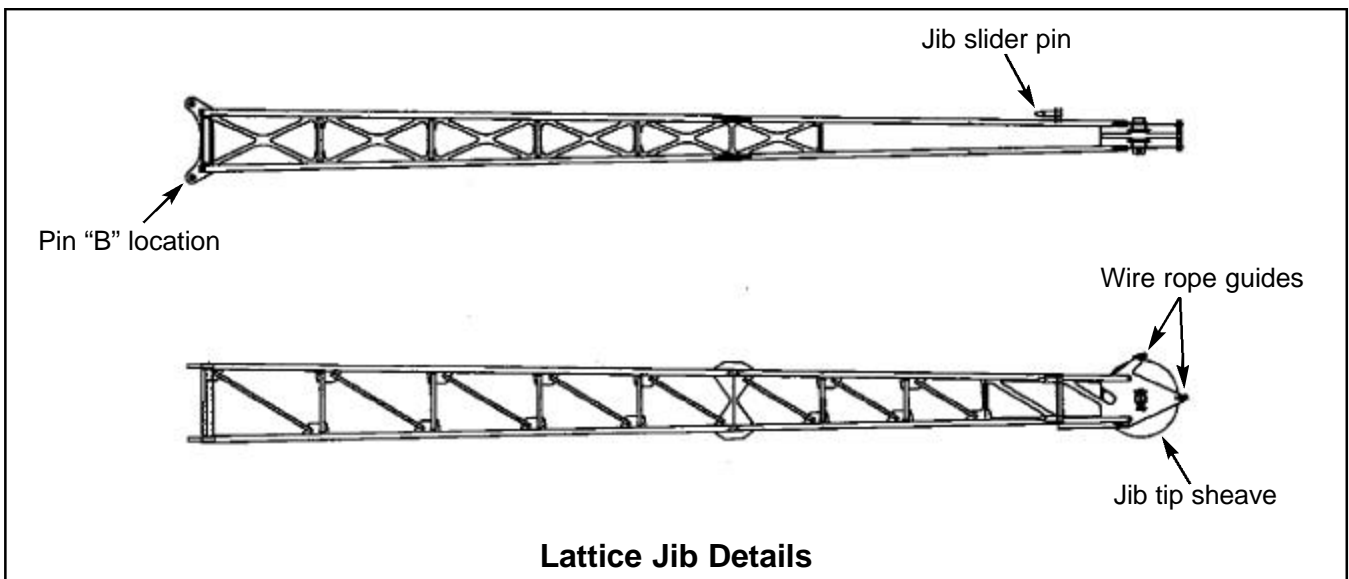

Lattice Jib Details

WARNING:

Do not route the wire rope under the top guide in the boom head.

Stowing the Extension

1. Retract the boom fully and lower it to a horizontal position. Remove the wire rope guides and retainers at the upper and lower extension sheaves.
2. Remove the becket and overhaul ball; retract the wire rope onto the auxiliary winch drum and secure it. Remove the extension lower sheave.
3. Unplug the the A2B switch at the pivot location on the extension lower sheave and remove it from its pivot location. Remove the A2B jumper cable between the boom head and extension.
4. Install the jib transition bracket and the two pins "C" securing it to the extension tip. Install the through-bolts near the handle end of the pins.
5. Extend the boom approximately 1 meter (3 ft). Remove all but the two far right pins "A" from

the extension back alongside the jib and main boom.

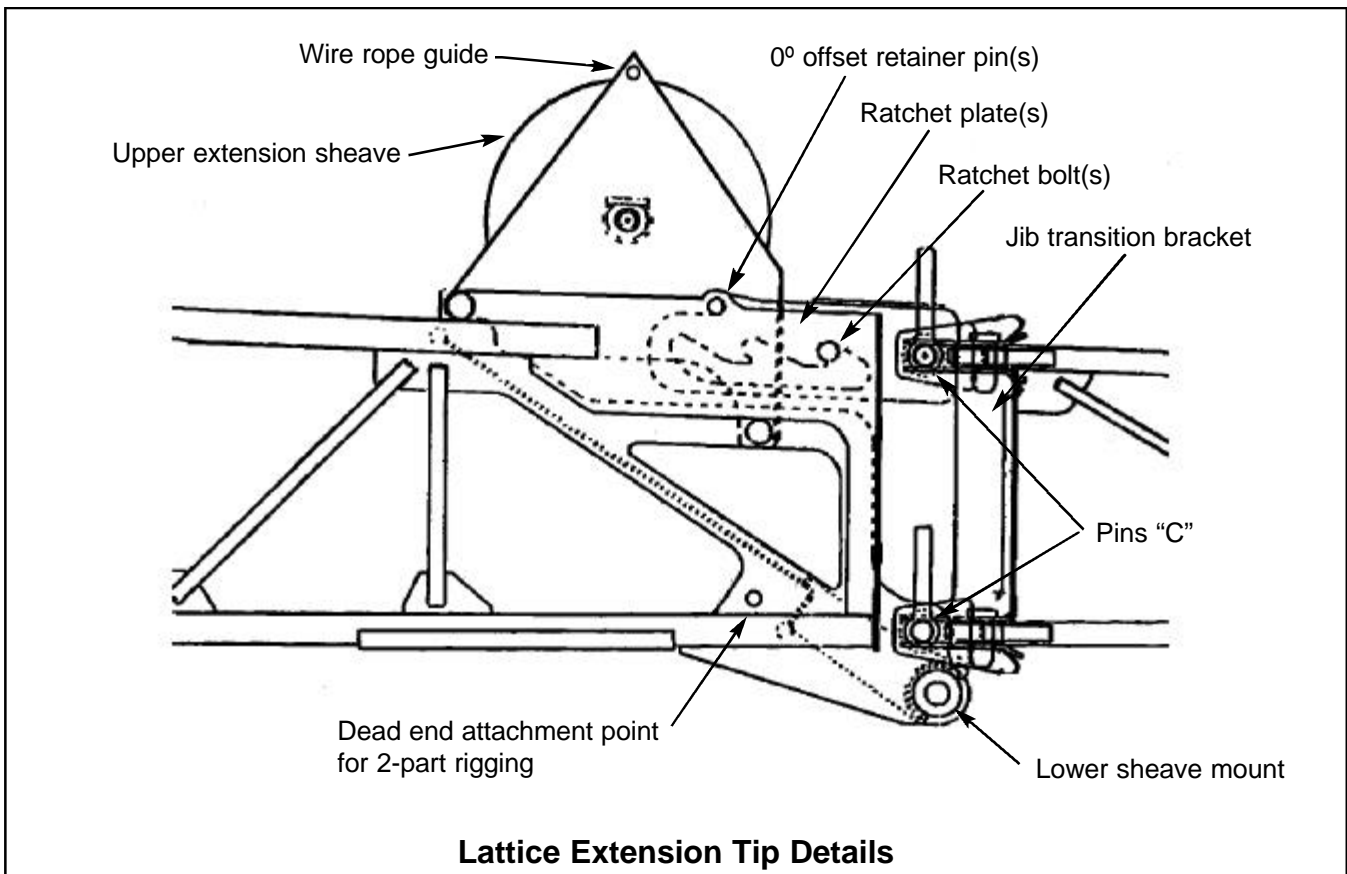

the extension and main boom bosses. Swing

-
6. While holding pressure on the tag line to force the extension toward the jib and boom, slowly retract the boom. Watch to make sure that all hooks, slider pins, and corresponding mounts are engaging properly. Retract the boom as far as it will go.
 7. Raise the boom to approximately 30° above horizontal, or until the extension settles fully on its stowage brackets. Lower the boom to horizontal and install the retainers at the extension slider pin locations on the main boom.
 8. Replace the two pins “B” which connect the jib to the jib transition bracket in the stowed position.
 9. Remove the pins “A” attaching the extension to the far right pin bosses on the boom head. Stow these pins and their retainers, as well as all other parts removed during this procedure, in the crane storage box under the hydraulic fluid tank.

Erecting and Rigging the Extension and Jib

Follow the steps below to erect the extension and jib from their stowed position.

1. Retract the boom fully and lower it to a horizontal position.
2. The two far right pin bosses on the boom head should be aligned with the pin bosses on the extension. Insert two pins “A” into the two aligned holes of the boom head and extension and install retainers on them.
3. Attach a tag line to the lower chord of the extension near the butt end of the main boom. Remove two pins “B” connecting the jib to the stowage bracket on the main boom. Remove the retainers from the extension and jib slider pin locations on the main boom.
4. Raise the boom to a position slightly above horizontal. Extend the boom slowly until the extension and jib slider pins clear their mating pockets and the extension hook clears the extension alignment ramp.

APPENDIX M: TERMS & ABBREVIATIONS

5. Lower the boom to a full horizontal position. Use the tag line to swing the extension and jib into alignment with the main boom. The four remaining pin bosses on the boom head should now be aligned with the pin bosses on the extension. Insert four additional pins "A" into the four aligned pairs of bosses on the boom head and extension. Install retainers on all pins "A".
6. Attach a tag line to a lower chord of the jib tip. Unlock the jib-to-extension retainer pin and swing the jib into alignment with the extension. The two remaining pin bosses on the extension tip should now be aligned with the pin bosses on the jib. Insert two additional pins "B" into the two aligned pairs of bosses on the extension and jib. Install retainers on all pins "B".

To offset the jib to 15° or 30° positions, proceed with Step 7. Otherwise skip ahead to Step 10.

7. Remove the 0° offset retaining pins and store them. Lower the boom until the jib tip rests on wood blocking on a truck or trailer.

8. Lower the boom further until there is no pressure on the offset ratchet bolts and the ratchet plates can swing up free of the bolts.

NOTE:

Do not remove the offset ratchet bolts to perform this operation.

9. Using a prybar, lift the ratchet plates and hold them clear of the ratchet bolts. Raise the boom slowly. When the ratchet bolts begin to slip into the proper notch (2nd notch = 15° offset, 3rd notch = 30°) in the ratchet plates, remove the prybar. Continue raising the boom until the jib tip rises clear of the blocking.

WARNING:

Do not lift the ratchet plates with your hands; always use a prybar and keep your hands completely clear of all pinch points.

10. Install the jib tip sheave and rope guide pins. Install all pin retainers.

-
11. Route the wire rope from the auxiliary winch drum over the top wire rope guide in the boom head, over the top sheave at the extension tip, and over the jib tip sheave. Install the wedge and socket (becket) and overhaul ball.

WARNING:

Do not route the wire rope under the top guide in the boom head.

12. Install the wire rope guide at the top extension tip sheave and the two guides at the jib tip sheave. Check to see that all pins and retainers are properly installed and secured.
13. Install A2B jumper cables between the boom head and extension and between the extension and jib. Plug the male connectors into the female receptacles. Install the A2B switch at the pivot location on the jib head and plug it into its receptacle.

Stowing the Extension and Jib

1. Retract the boom fully and lower it to a horizontal position. Remove the wire rope guide and retainer at the top extension tip sheave and the two guides and retainers at the jib tip sheave.
2. Remove the becket and overhaul ball; retract the wire rope onto the auxiliary winch drum and secure it. Remove the jib tip sheave.

If the jib is in the 15° or 30° offset position, proceed with Step 3. Otherwise skip ahead to Step 5.

3. Lower the boom until the jib tip rests on wood blocking on a truck or trailer.
4. Lower the boom further until the ratchet bolts slip into the 0° notches of the ratchet plates. Raise the boom until the jib tip rises clear of the blocking. Install and secure the 0° offset retaining pins. Raise the boom to a horizontal position.
5. Attach a tag line to a lower chord of the jib tip. Remove the two pins "B" and their retainers from the left side bosses on the extension tip. Swing the jib back alongside the extension until the jib-to-extension retaining pin locks the jib and extension together.